

Spare Parts List:

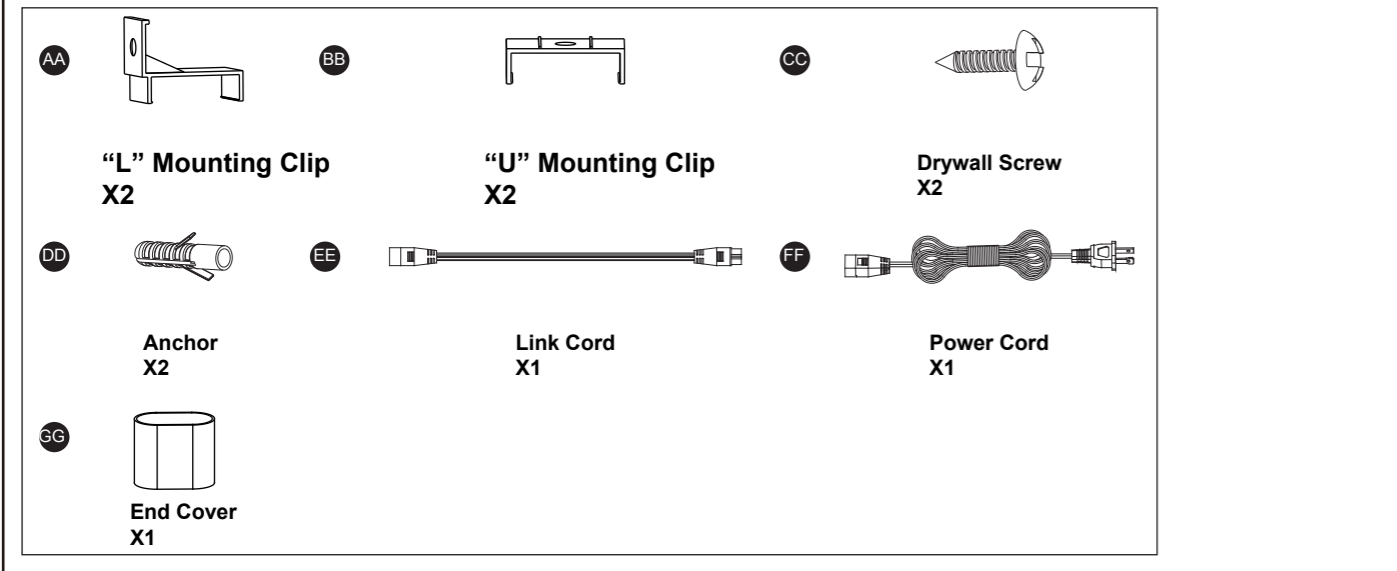

CARE AND MAINTENANCE

Caution: Before attempting to clean the fixture, disconnect the power to the fixture by turning the breaker off or removing the fuse from the fuse box.

This LED light fixture is made from quality materials that will last many years with minimum care. You may want to periodically clean the fixture with a soft cloth. To maintain the best appearance of the fixture, do not use cleaners with chemicals, solvents or harsh abrasives. Do not use liquid cleaner on the LEDs, LED drive, or wiring inside the light fixture.

TROUBLESHOOTING

PROBLEM	POSSIBLE CAUSE	CORRECTIVE ACTION
The fixture doesn't light up	The power is off.	Check to ensure the power supply is on
	The circuit breaker is off.	Check to ensure the circuit breaker is in the on position
	There is a bad connection.	Check to ensure proper wire connections are made. Contact a qualified electrician.
	There is a defective switch.	Contact a qualified electrician.
The fuse blown or circuit breaker trips when the light is turn on.	The wires are crossed or the power wire is grounding out.	Check to ensure proper wire connections are made. Contact a qualified electrician.

PACKAGE CONTENTS

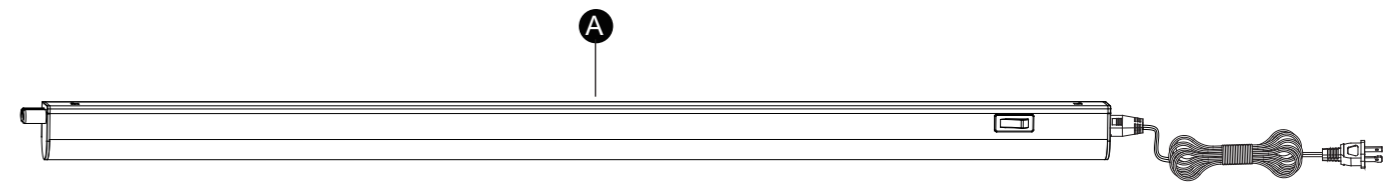

HARDWARE CONTENTS Note: Hardware not shown actual size.

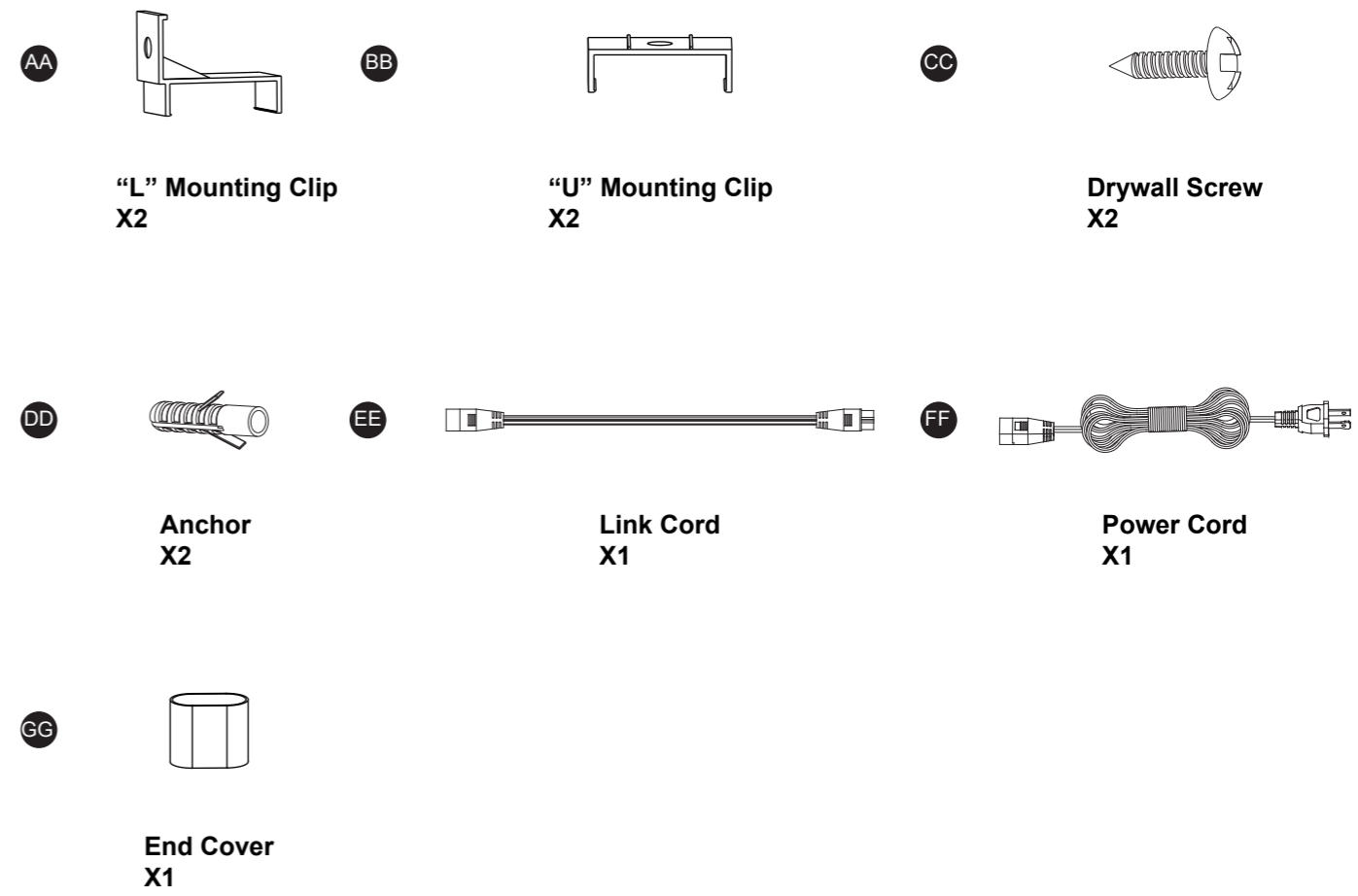

SAFETY INFORMATION

Please read and understand this entire manual before attempting to assemble, operate or install the product.

WARNING

- Turn off electricity at main fuse box (or circuit breaker box) before beginning installation by removing fuse (or switching off circuit breaker).
- Be careful not to damage or cut the wire insulation (covering) during fixture installation. Do not permit wires to contact any surface having a sharp edge. To do so may damage or cut the wire insulation, which could cause serious injury or death from electric shock.
- LED electronics can be damaged by electro static discharge (ESD) shock. Before installation, discharge yourself by touching a grounded bare metal surface to remove this hazard. To avoid damage, do not touch the LED module.

CAUTION

- All electrical connections must be in agreement with local codes, ordinances or the national electric code (NEC). Contact your municipal building department to learn about your local codes, permits and/or inspections.
- Risk of fire – most dwellings built before 1985 have supply wire rated for 140°F/60°C. Consult a qualified electrician before installation.

PREPARATION

Before beginning assembly, installation or operation of product, make sure all parts are present. Compare parts with package contents list and diagram on previous page. If any part is missing or damaged, do not attempt to assemble, install or operate the product. Contact customer service for replacement parts.

Tools Required for Assembly (not included): Screwdriver, Phillips Screwdriver, Pliers, Electrical Tape, Wire Cutters, Safety Glasses, Ladder, Wire Stripper.

ASSEMBLY INSTRUCTIONS

Important to know

1. Do not use in wet locations, use indoors only.
2. Non-replaceable LEDs.
3. Caution: LEDs emit bright light. Avoid looking directly into the light source for prolonged periods to avoid eye damage.
4. Specification: See right table.

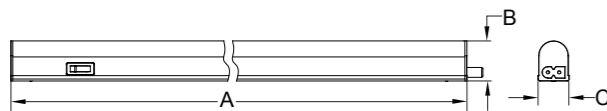

NO.	Item #.	Dimension(inch)			Watts
		A	B	C	
1	SP34130	12.32	1.18	0.91	5
2	SP34131	21.38	1.18	0.91	7
3	SP34132	22.56	1.18	0.91	9
4	SP34133	34.37	1.18	0.91	12
5	SP34134	46.18	1.18	0.91	16

Installation Steps

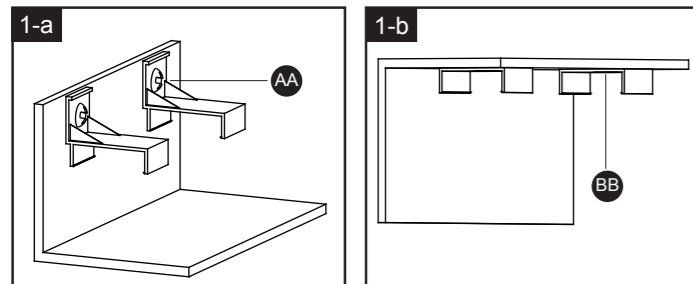

1. • Identify and mark the desired location for the LED fixture, then place the "L" mounting clips (AA) or "U" mounting clips (BB) in the desired location and mark the intended positions of the holes with a pencil.
 - The distance of two spots is less than the length of the light and more than the half length of the light.

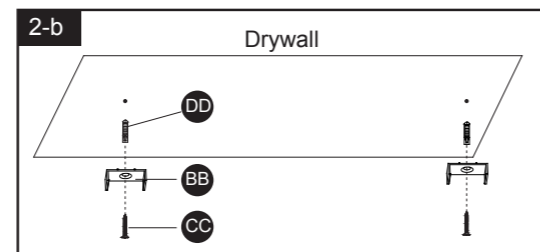
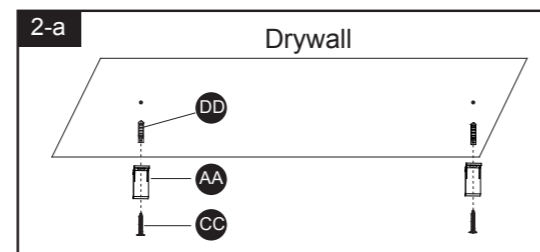

2. **For mounting to drywall :**
Drill holes at the two location. Insert the anchors (DD) through the holes of the side drywall, attach the "L" mounting clips (AA) or the "U" mounting clips (BB) to anchors (DD), then secure them with drywall screws (CC).

ASSEMBLY INSTRUCTIONS (continued)

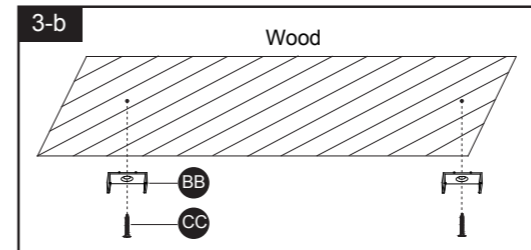
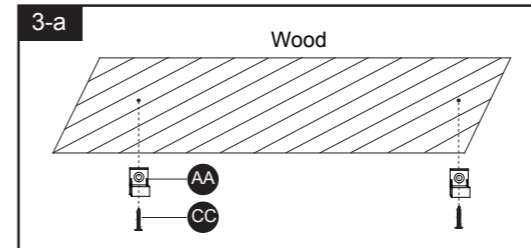

3. **For mounting to wood**
Attach the "L" mounting clips (AA) or the "U" mounting clips (BB) to the location at wood, then secure them with drywall screws (CC).

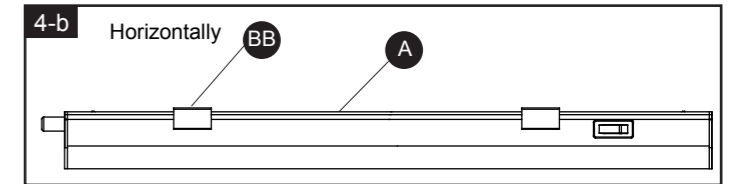
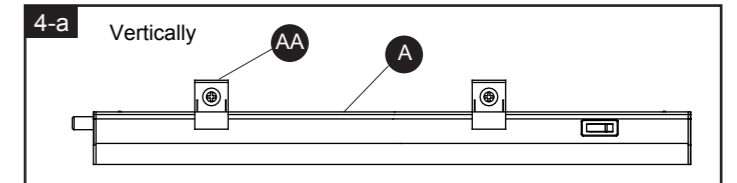

4. Attach the light fixture (A) to the "L" mounting clips (AA) or the "U" mounting clips (BB) by sliding one side of the fixture into the "L" mounting clips (AA) or the "U" mounting clips (BB) first, then press and push the other side of the fixture into the "L" mounting clips (AA) or the "U" mounting clips (BB).

5. Plug the connector of the power cord (FF) into light fixture (A) and plug the power (FF) into outlet.

Note: This power cord has a polarized plug (one blade is wider than the other) as a feature to reduce the risk of electric shock. This plug will fit in a polarized outlet only one way. If the plug does not fit fully in the outlet, reverse the plug. If it still does not fit, contact a qualified electrician.

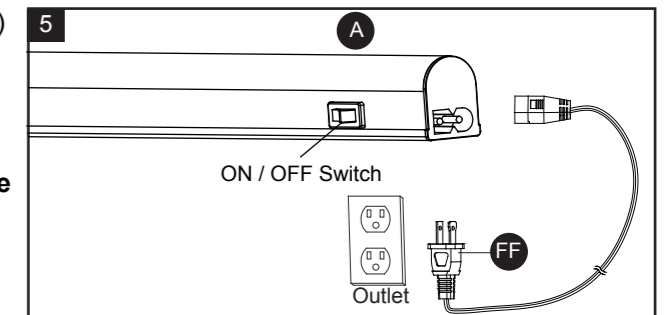

6. Linking multiple fixtures:

The LED tube light fixture can be connected together in series without any connector or using linking cord included with this product. Maximum link up to 20pcs of 22" tube lights (#348-0608), or link up to 10pcs of 46" tube lights (#348-0609). Only the first light fixture needs to be plugged into an electrical outlet or direct wired to an electrical box.

- If intermixing different lengths, do not exceed 180 watts in any single run.
- Provide power to the fixtures only after all linking connections have been made.
- Connect each additional fixture without any connector or using the linking cord (EE). Remove the end cover (GG) and connect each other directly or insert linking cord (EE) into the receptacle in the end of each fixture body. When using the linking cord (EE), the maximum distance between two light fixtures is 12" using the linking cord (EE) provided.

