

CoreTech CRI80 Type C Lamp

Commercial Grade LED Lamp

Features & Benefits

- Advanced dimming with Pro-DIM technology: 0-10V and/or AB dimming
- No Polarity: lamp ends can be reversed
- Same wiring as fluorescent lamp/ballast system
- UL 1598C for safety
- Full glass as fluorescent T5
- Smooth, Consistent Light
- Suitable for Dry and Damp Locations
- High CRI
- Instant on
- 50,000 hours with no limitation on On/Off Cycles
- Evaluated for use in totally enclosed, recessed luminaires, surface mount wall and ceiling luminaires, outdoor luminaires (open surface mount luminaires with compartment protection from weather)
- For use with Class 2 driver only
- 5 Year Warranty



Product Certification



Specification Data

Model	Lamp Input Current	System Wattage	Lamp Wattage	Length	CRI	Initial Lumens	Lamp Efficacy (lm/W)	System Efficacy (lm/W)	Beam Angle	CCT
L36T5/830/18G-XT	250mA	12	9	36"	82	1400	155	116	240	3000K
L36T5/830/18G-XT	360mA	16	13	36"	82	1900	146	118	240	3000K
L36T5/830/18G-XT	500mA	21	18	36"	82	2500	139	119	240	3000K

Wiring Diagram

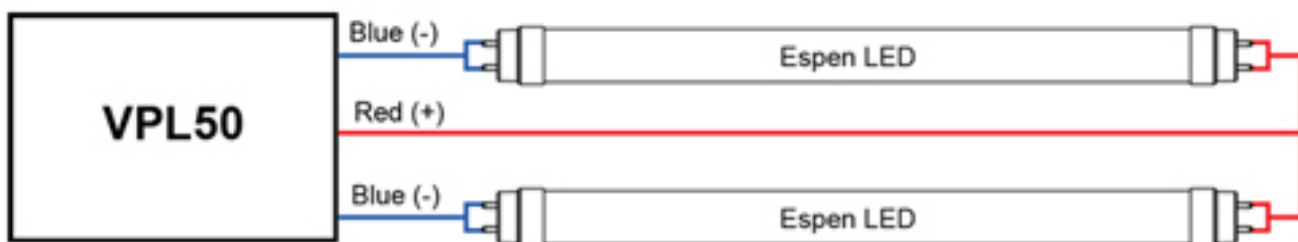

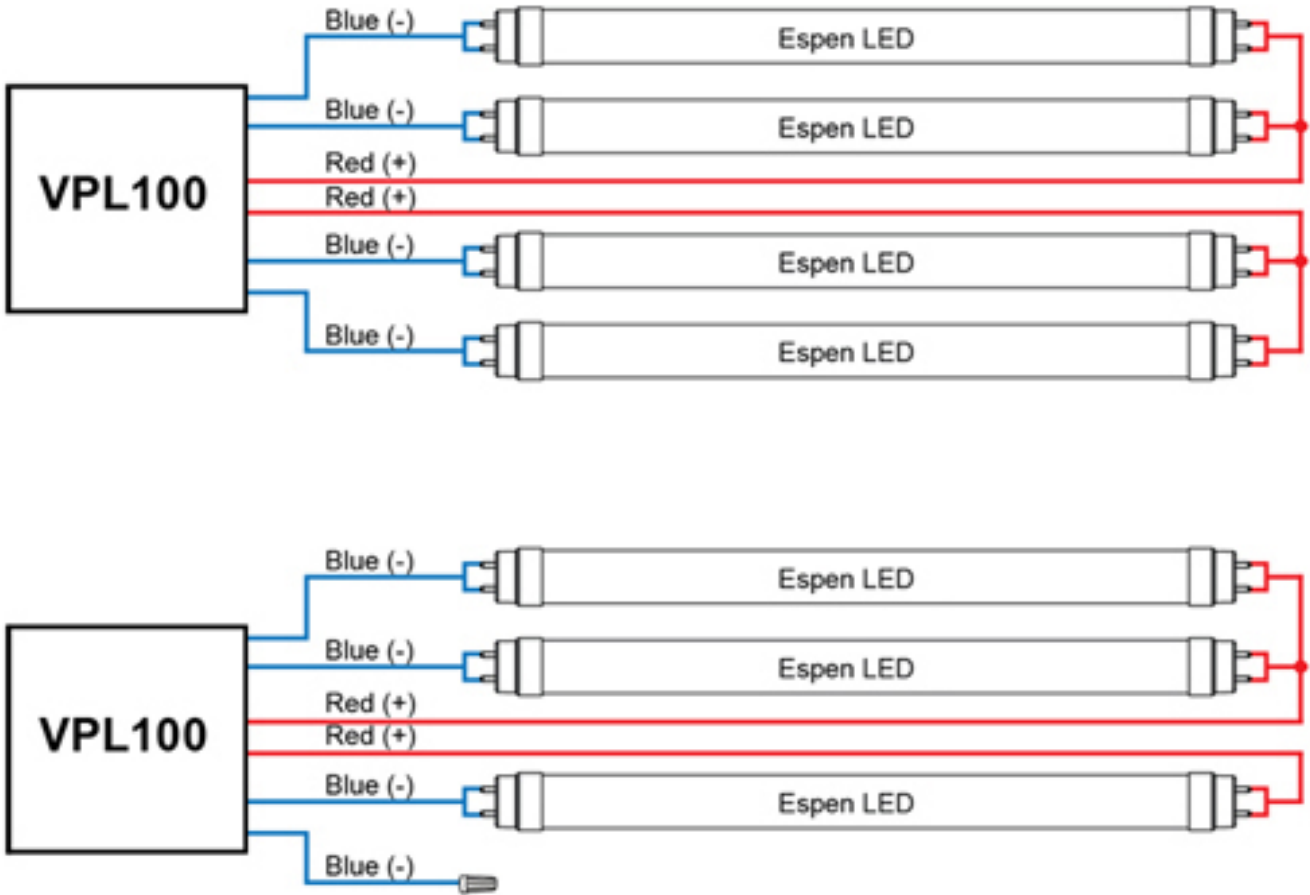

Dlc Information

Order Code	Lamp Input Current	DLC Product ID	DLC Product Model	DLC Version
L36T5/830/18G-XT	250mA	N/A	N/A	N/A
L36T5/830/18G-XT	360mA	N/A	N/A	N/A
L36T5/830/18G-XT	500mA	N/A	N/A	N/A

Specification data is based on tests performed in a controlled environment and represents relative performance. Actual performance can vary depending on operating conditions. Application and performance data subject to change without notice. All specifications are nominal unless noted otherwise.