

Channel Retrofit Kits

Commercial Grade LED Linear Retrofit Kits



Product Certification

[*Emergency Driver Solution Option](#)

Content

- VPL100-4C, Field-Adjustable Multi Channel Constant Current Driver
- (4) VLM3612F/8XX Linear LED Module
- User Manual [versaLinear_kit_Installation_Guide_2021.10.7.pdf](#)

Description

UL 1598C Classified LED retrofit kits with linear modules, for any linear applications such as troffer, wraparound, strips, etc.

Features

- Driver + Module kits, no lamp socket needed
- Magnet on the back for easy installation
- UL 1598C Classified Retrofit Kits
- UL Class 2 Low Voltage System
- 3 Steps MacAdam Steps for Accurate Color
- Long life 50,000 hours
- 5 Years Warranty of Whole System
- Universal Input 120/277V
- 0-10V Dimming
- NSF 2 Complied with PC lens
- Aluminum backing for heatsink, independent to Fixtures
- True Multi Channel Operation
- Programmable with Multiple Light Levels
- Flicker-free, Meets IEEE 1798-2015

Specification Data

Kit Order Code	Application	Mode	Kit Model	System Lumen	System Wattage	System Efficacy	CRI	Module	Driver	Power Factor	THD
VEKM-L34F/850	4 lamp, 3ft 5000K	Low Wattage	D547-4M-303 F/850	4550	42	108	83	VLM3612F/850	VPL100-4C	>0.9	<20%
VEKM-L34F/850	4 lamp, 3ft 5000K	Normal Wattage	D547-4M-303 F/850	5400	50	108	83	VLM3612F/850	VPL100-4C	>0.9	<20%
VEKM-L34F/850	4 lamp, 3ft 5000K	High Wattage	D547-4M-303 F/850	6500	60	108	83	VLM3612F/850	VPL100-4C	>0.9	<20%

Order Information

EXAMPLE: VEKM42F/HO/840

VEKM	4	2	F	/	HO	/	8	40
VersaLinear Linear Retrofit Module Kit	Module Length 4 - 4ft 3 - 3ft 2 - 2ft	Module Quantity 1 - 1 Module 2 - 2 Modules 3 - 3 Modules 4 - 4 Modules	Lens F - Frosted C - Clear (No Lens)	/	Output Mode Empty - Normal Output HO - High Output VHO - Very High Output	/	CRI 8 - CRI > 80	CCT 30 - 3000K 35 - 3500K 40 - 4000K 50 - 5000K

Module Dimensions

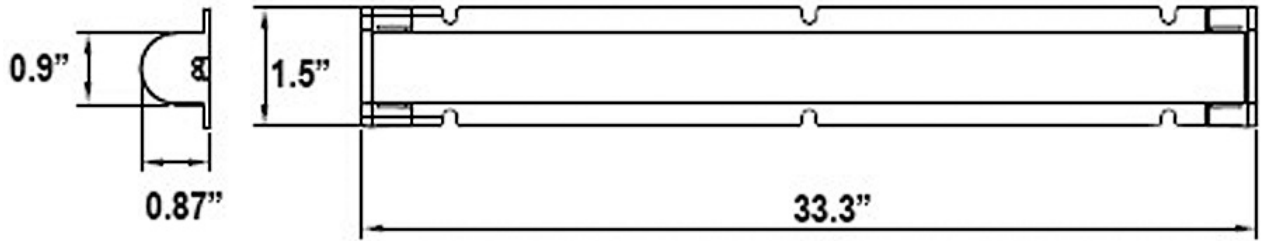

Driver Dimensions

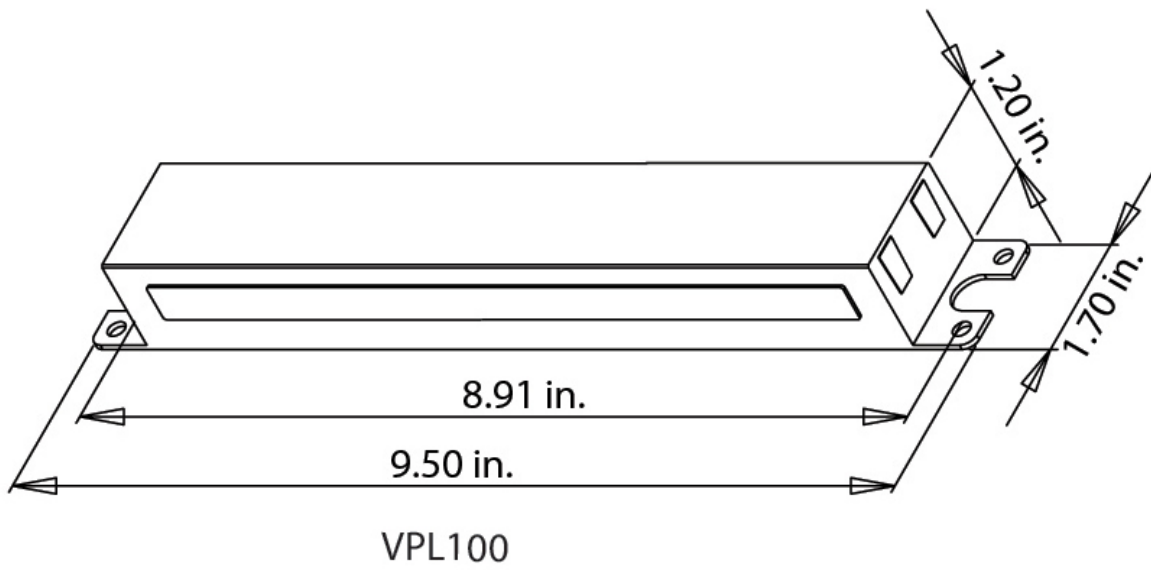

Wiring Diagram

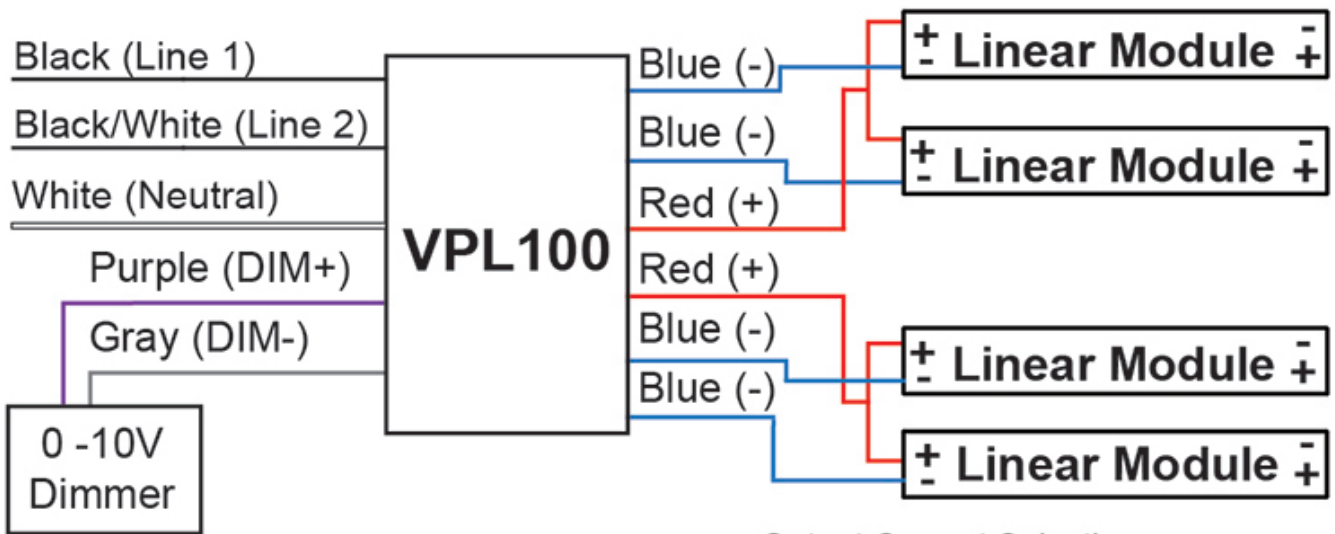

Output Current Selection

Input Line	Output Current
L1 (BLK)	300mA
L2 (BLK/WHT)	250mA
L1 + L2	360mA

Dlc Information

Order Code	Mode	DLC Product ID	DLC Product Model	DLC Version
VEKM-L34F/850	Low Wattage	N/A	N/A	N/A
VEKM-L34F/850	Normal Wattage	N/A	N/A	N/A
VEKM-L34F/850	High Wattage	N/A	N/A	N/A

Specification data is based on tests performed in a controlled environment and represents relative performance. Actual performance can vary depending on operating conditions. Application and performance data subject to change without notice. All specifications are nominal unless noted otherwise.