

## LED Luminaires

### ProLED Select Compact Linear High Bay Series

- Compact Design To Reduce Shipping Costs, and Reduce Installation Time
- Big performance, 12,000 to 45,000 Lumens in 3 sizes, 4 CCT Selectable SKUs
- Operates in Ambient Temperatures up to 50° C
- Frosted Acrylic Lens To Eliminate Glare

### Specifications



### Description

The Compact Linear High Bay (CLHB) is designed to meet the needs of the budget-conscious contractor. CLHB boasts robust performance in a smaller footprint to save space and cut down installation time. Designed with a durable die-cast aluminum housing and matte acrylic lens to eliminate glare, the CLHB is a reliable solution for light-duty industrial applications like warehouses, without sacrificing quality needed in retail stores, gymnasiums, and other large indoor spaces.

### Performance

- Selectable color temperatures 4000K / 5000K
- 136+ lumens per watt
- 80+ CRI
- L70 lumen maintenance > 50,000 hours
- 0-10V dimming
- 120-277VAC input
- 5 year limited warranty

### Construction

- Die-cast aluminum housing
- Acrylic, matte lens
- 1/2" Knock outs on top, sides and bottom
- Chain and v hook mount (standard)
- Wire guard, Pendant Mount, Surface Mount (accessories)
- Optional stepdown transformer
- Optional battery backup

### Certifications

- DLC 5.1 Premium
- UL
- cULus
- ROHS compliant
- FCC
- Environmental Rating IP20, UL Damp Location Rating

### Controls

- 0-10 VDC dimming standard
- RF bi-level occupancy sensing
- PIR bi-level occupancy sensing

## ProLED Select Compact Linear High Bay Series

### Ordering Logic

Series	Base Lumens	Wattage	CCT	Voltage	Options
CLHB = Compact Linear High Bay	1 = 12,010 Lumens 2 = 19,859 Lumens 3 = 25,540 Lumens 4 = 32,450 Lumens	<b>WS = Wattage Selectable</b> 1 ( 90W / 110W / 130W ) 2 ( 140W / 150W / 165W ) 3 ( 180W / 200W / 220W ) 4 ( 240W / 280W / 320W )	<b>CS = Color Selectable</b> /4000K/5000K	<b>U = 120-277VAC</b> <b>H = 347-480VAC</b>	<b>EM = Battery Backup</b> <b>PIRMS = Side Mount PIR</b> Occupancy Sensing

### Ordering Information

Product SKU	Product Code	Product Description
36100	CLHB-1-WS-CS-U	ProLED Select Compact Linear High Bay Wattage Selectable (12,010-17,588 lumens, 90W-110W-130W) Color Selectable 4000K-5000K, Universal Voltage 120-277VAC with Chain and V Hook Mount
36101	CLHB-2-WS-CS-U	ProLED Select Compact Linear High Bay Wattage Selectable (19,859-23,736 lumens, 140W-150W-165W), Color Selectable 4000K-5000K, Universal Voltage 120-277VAC with Chain and V Hook Mount
36102	CLHB-3-WS-CS-U	ProLED Select Compact Linear High Bay Wattage Selectable (24,540-31,023 lumens, 180W-200W-220W), Color Selectable 4000K-5000K, Universal Voltage 120-277VAC with Chain and V Hook Mount
36103	CLHB-4-WS-CS-U	ProLED Select Compact Linear High Bay Wattage Selectable (32,450-45,237 lumens, 240W-280W-320W) Color Selectable 4000K-5000K, Universal Voltage 120-277VAC with Chain and V Hook Mount
Accessories		
24875*	DCMS	DC Bi-Level Motion Sensor
24975	DCMSPIR	DC Bi-Level PIR (Passive Infrared) Motion Sensor
24876	DCMS-REM	DC Bi-Level Motion Sensor Remote
99986	LHB/MC	(0-10V) Motion Control Sensor LSXR 610 HL - Side Knockout Install
36148	CLHB-1-A-WG	Wire Guard for CLHB-1
36149	CLHB-2-A-WG	Wire Guard for CLHB-2
36150	CLHB-34-A-WG	Wire Guard for CLHB- 3, CLHB-4
36151	CLHB-12-M-PEND	Pendant Mount for CLHB-1, CLHB-2
36152	CLHB-12-M-SURF	Surface Mount for CLHB-1, CLHB-2
36153	CLHB-34-M-PEND	Pendant Mount for CLHB-3 CLHB-4
36154	CLHB-34-M-SURF	Surface Mount for CLHB-3 CLHB-4
36155	CLHB-BBU-9	Battery Backup (9W/90Min) for CLHB
36156	CLHB-12-DR-480V	Driver (150W) 277-480VAC for CLHB-1 CLHB-2
36157	CLHB-3-DR-480V	Driver (200W) 277-480VAC for CLHB-3
36158	CLHB-4-DR-480V	Driver (320W) 277-480VAC for CLHB-4

\*When using CLHB-BBU-9 or 16 and DCMS Motion Sensor, DCMS sensor must be set to ∞ standby time on the motion sensor remote. This setting allows fixture to not turn off in EM mode.

## ProLED Select Compact Linear High Bay Series

Non Stock Product SKU	Product Code	Product Description
36106	CLHB-1-WS-CS-U-PIRMS	ProLED Select Compact Linear Highbay 1, Wattage Selectable 130W-110W-90W, Color Selectable 4000K-5000K, Universal Voltage 120-277VAC with Suspended Chain Mount with PIR Motion Sensor
36107	CLHB-1-WS-CS-U-EM	ProLED Select Compact Linear Highbay 1, Wattage Selectable 130W-110W-90W, Color Selectable 4000K-5000K, Universal Voltage 120-277VAC with Suspended Chain Mount with Emergency Battery Backup
36108	CLHB-1-WS-CS-U-EM-PIRMS	ProLED Select Compact Linear Highbay 1, Wattage Selectable 130W-110W-90W, Color Selectable 4000K-5000K, Universal Voltage 120-277VAC with Suspended Chain Mount with Emergency Battery Backup and PIR Motion Sensor
36109	CLHB-1-WS-CS-H	ProLED Select Compact Linear Highbay 1, Wattage Selectable 130W-110W-90W, Color Selectable 4000K-5000K, Universal Voltage 277-480VAC with Suspended Chain Mount
36110	CLHB-1-WS-CS-H-PIRMS	ProLED Select Compact Linear Highbay 1, Wattage Selectable 130W-110W-90W, Color Selectable 4000K-5000K, Universal Voltage 277-480VAC with Suspended Chain Mount with PIR Motion Sensor
36111	CLHB-1-WS-CS-H-EM	ProLED Select Compact Linear Highbay 1, Wattage Selectable 130W-110W-90W, Color Selectable 4000K-5000K, Universal Voltage 277-480VAC with Suspended Chain Mount with Emergency Battery Backup
36112	CLHB-1-WS-CS-H-EM-PIRMS	ProLED Select Compact Linear Highbay 1, Wattage Selectable 130W-110W-90W, Color Selectable 4000K-5000K, Universal Voltage 277-480VAC with Suspended Chain Mount with Emergency Battery Backup and PIR Motion Sensor
36113	CLHB-2-WS-CS-U-PIRMS	ProLED Select Compact Linear Highbay 2, Wattage Selectable 165W-150W-140W, Color Selectable 4000K-5000K, Universal Voltage 120-277VAC with Suspended Chain Mount with PIR Motion Sensor
36114	CLHB-2-WS-CS-U-EM	ProLED Select Compact Linear Highbay 2, Wattage Selectable 165W-150W-140W, Color Selectable 4000K-5000K, Universal Voltage 120-277VAC with Suspended Chain Mount with Emergency Battery Backup
36115	CLHB-2-WS-CS-U-EM-PIRMS	ProLED Select Compact Linear Highbay 2, Wattage Selectable 165W-150W-140W, Color Selectable 4000K-5000K, Universal Voltage 120-277VAC with Suspended Chain Mount with Emergency Battery Backup and PIR Motion Sensor
36116	CLHB-2-WS-CS-H	ProLED Select Compact Linear Highbay 2, Wattage Selectable 165W-150W-140W, Color Selectable 4000K-5000K, Universal Voltage 277-480VAC with Suspended Chain Mount
36117	CLHB-2-WS-CS-H-PIRMS	ProLED Select Compact Linear Highbay 2, Wattage Selectable 165W-150W-140W, Color Selectable 4000K-5000K, Universal Voltage 277-480VAC with Suspended Chain Mount with PIR Motion Sensor
36118	CLHB-2-WS-CS-H-EM	ProLED Select Compact Linear Highbay 2, Wattage Selectable 165W-150W-140W, Color Selectable 4000K-5000K, Universal Voltage 277-480VAC with Suspended Chain Mount with Emergency Battery Backup
36119	CLHB-2-WS-CS-H-EM-PIRMS	ProLED Select Compact Linear Highbay 2, Wattage Selectable 165W-150W-140W, Color Selectable 4000K-5000K, Universal Voltage 277-480VAC with Suspended Chain Mount with Emergency Battery Backup and PIR Motion Sensor
36120	CLHB-3-WS-CS-U-PIRMS	ProLED Select Compact Linear Highbay 3, Wattage Selectable 220W-200W-180W, Color Selectable 4000K-5000K, Universal Voltage 120-277VAC with Suspended Chain Mount with PIR Motion Sensor
36121	CLHB-3-WS-CS-U-EM	ProLED Select Compact Linear Highbay 3, Wattage Selectable 220W-200W-180W, Color Selectable 4000K-5000K, Universal Voltage 120-277VAC with Suspended Chain Mount with Emergency Battery Backup
36122	CLHB-3-WS-CS-U-EM-PIRMS	ProLED Select Compact Linear Highbay 3, Wattage Selectable 220W-200W-180W, Color Selectable 4000K-5000K, Universal Voltage 120-277VAC with Suspended Chain Mount with Emergency Battery Backup and PIR Motion Sensor
36123	CLHB-3-WS-CS-H	ProLED Select Compact Linear Highbay 3, Wattage Selectable 220W-200W-180W, Color Selectable 4000K-5000K, Universal Voltage 277-480VAC with Suspended Chain Mount
36124	CLHB-3-WS-CS-H-PIRMS	ProLED Select Compact Linear Highbay 3, Wattage Selectable 220W-200W-180W, Color Selectable 4000K-5000K, Universal Voltage 277-480VAC with Suspended Chain Mount with PIR Motion Sensor
36125	CLHB-3-WS-CS-H-EM	ProLED Select Compact Linear Highbay 3, Wattage Selectable 220W-200W-180W, Color Selectable 4000K-5000K, Universal Voltage 277-480VAC with Suspended Chain Mount with Emergency Battery Backup
36126	CLHB-3-WS-CS-H-EM-PIRMS	ProLED Select Compact Linear Highbay 3, Wattage Selectable 220W-200W-180W, Color Selectable 4000K-5000K, Universal Voltage 277-480VAC with Suspended Chain Mount with Emergency Battery Backup and IR Motion Sensor
36127	CLHB-4-WS-CS-U-PIRMS	ProLED Select Compact Linear Highbay 4, Wattage Selectable 320W-280W-240W, Color Selectable 4000K-5000K, Universal Voltage 120-277VAC with Suspended Chain Mount with PIR Motion Sensor
36128	CLHB-4-WS-CS-U-EM	ProLED Select Compact Linear Highbay 4, Wattage Selectable 320W-280W-240W, Color Selectable 4000K-5000K, Universal Voltage 120-277VAC with Suspended Chain Mount with Emergency Battery Backup
36129	CLHB-4-WS-CS-U-EM-PIRMS	ProLED Select Compact Linear Highbay 4, Wattage Selectable 320W-280W-240W, Color Selectable 4000K-5000K, Universal Voltage 120-277VAC with Suspended Chain Mount with Emergency Battery Backup and PIR Motion Sensor
36130	CLHB-4-WS-CS-H	ProLED Select Compact Linear Highbay 4, Wattage Selectable 320W-280W-240W, Color Selectable 4000K-5000K, Universal Voltage 277-480VAC with Suspended Chain Mount
36131	CLHB-4-WS-CS-H-PIRMS	ProLED Select Compact Linear Highbay 4, Wattage Selectable 320W-280W-240W, Color Selectable 4000K-5000K, Universal Voltage 277-480VAC with Suspended Chain Mount with PIR Motion Sensor
36132	CLHB-4-WS-CS-H-EM	ProLED Select Compact Linear Highbay 4, Wattage Selectable 320W-280W-240W, Color Selectable 4000K-5000K, Universal Voltage 277-480VAC with Suspended Chain Mount with Emergency Battery Backup
36133	CLHB-4-WS-CS-H-EM-PIRMS	ProLED Select Compact Linear Highbay 4, Wattage Selectable 320W-280W-240W, Color Selectable 4000K-5000K, Universal Voltage 277-480VAC with Suspended Chain Mount with Emergency Battery Backup and PIR Motion Sensor

## ProLED Select Compact Linear High Bay Series

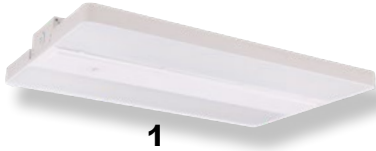

1



2



3, 4

### Product Selector

Watts	Color Temp	Base Part # 120-277V	With DC Bi-Level PIR Motion Sensor	With 480V	480V With DC Bi-Level PIR Motion Sensor	With Emergency Battery Backup	Battery Backup With DC Bi-Level PIR Motion Sensor	480V with Emergency Battery Backup	480V with Emergency Battery Backup and With DC Bi-Level PIR Motion Sensor
1 (90W / 110W / 130W) 12,010-17,588 Lumens	4000K/5000K	36100	36106	36109	36110	36107	36108	36111	36112
2 (140W / 150W / 165W) 19,859-23,736 Lumens	4000K/5000K	36101	36113	36116	36117	36114	36115	36118	36119
3 (180W / 200W / 220W) 24,540-31,023 Lumens	4000K/5000K	36102	36120	36123	36124	36121	36122	36125	36126
4 (240W / 280W / 320W) 32,450-45,237 Lumens	4000K/5000K	36103	36127	36130	36131	36128	36129	36132	36133



Pendant Mount

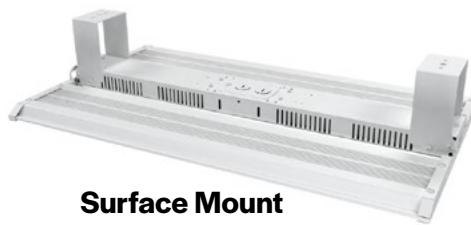

Surface Mount

### Mount Selector

Product SKU	Product Description
36151	Pendant Mount for CLHB-1, CLHB-2
36153	Pendant Mount for CLHB-3, CLHB-4
36152	Surface Mount for CLHB-1, CLHB-2
36154	Surface Mount for CLHB-3 CLHB-4

## ProLED Select Compact Linear High Bay Series

### Specifications Table

	CLHB-1-WS-CS-U	CLHB-2-WS-CS-U	CLHB-3-WS-CS-U	CLHB-4-WS-CS-U
<b>Nominal Wattage</b>	90W, 110W or 130W Selectable	140W, 150W or 165W Selectable	180W, 200W or 220W Selectable	240W, 280W or 320W Selectable
<b>Delivered Lumens</b>	12,010-17,588 Lumens	19,859-23,736 Lumens	24,540-31,023 Lumens	32,450-45,237 Lumens
<b>Efficacy (lm/W)</b>	134-137 LPW	141-143 LPW	140-143 LPW	140-143 LPW
<b>CCT</b>	4000K/ 5000K Selectable			
<b>CRI</b>	80+			
<b>L70 Lifetime (hrs)</b>	50,000			
<b>Voltage</b>	120-277VAC			
<b>Power Factor</b>	>0.9			
<b>Dimming</b>	0-10V			
<b>Housing Material</b>	Die-cast Aluminum with Powder Coated Finish			
<b>Lens</b>	Acrylic			
<b>Operating Temperature</b>	-40°-50° C			
<b>BUG</b>	B4 U3 G2	B4 U5 G1	B5 U5 G1	5 U5 G2
<b>Listings</b>	UL, cUL, DLC 5.1 Premium			
<b>Environment</b>	Environmental Rating IP20, UL Damp Location Rating			
<b>Weight</b>	5.73 lbs	6.83 lbs	9.26 lbs	10.14 lbs
<b>Warranty</b>	5 Years Standard			

### Performance Table

Product Code	Selectable Wattage	4000K		5000K	
		Lumen(lm)	Efficacy(lm/W)	Lumen(lm)	Efficacy(lm/W)
CLHB-1-WS-CS-U	90W	9590	137	9870	141
	110W	12240	136	12600	140
	130W	17420	134	18330	141
CLHB-2-WS-CS-U	140W	20020	143	20160	144
	150W	21150	141	21450	143
	165W	23265	141	23595	143
CLHB-3-WS-CS-U	180W	25740	143	26100	145
	200W	28200	141	28800	144
	220W	30800	140	30580	139
CLHB-4-WS-CS-U	240W	34800	145	35040	146
	280W	39200	140	40040	143
	320W	44800	140	44480	139

## ProLED Select Compact Linear High Bay Series

### Dimensions

CLHB-1

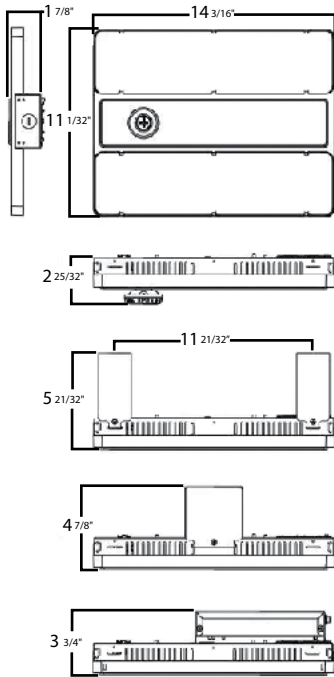

CLHB-2

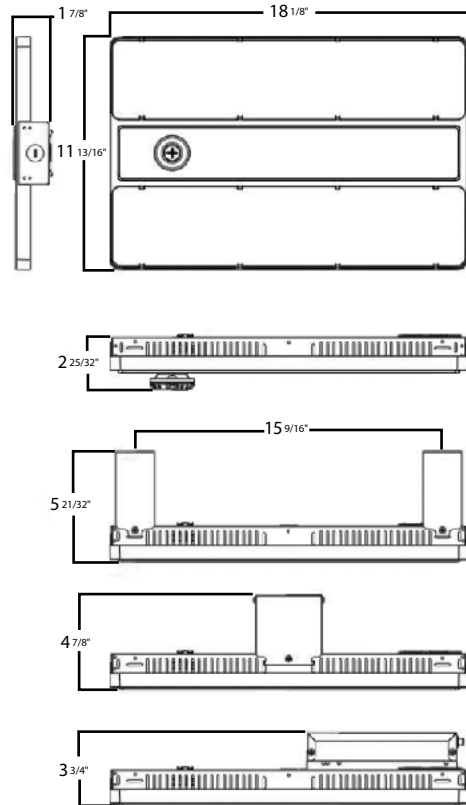

CLHB-3

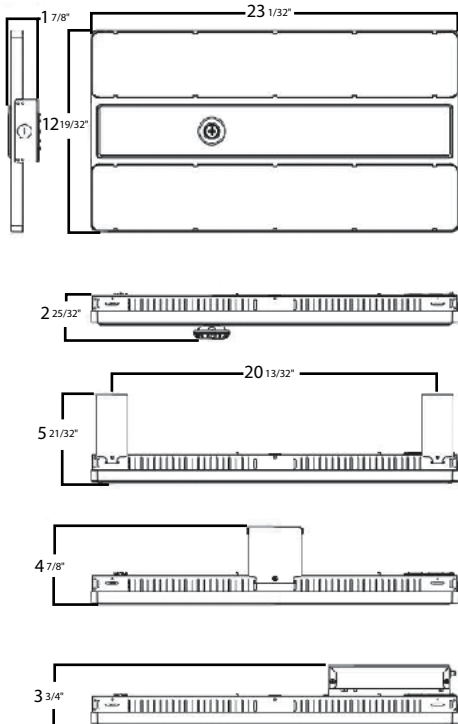

CLHB-4

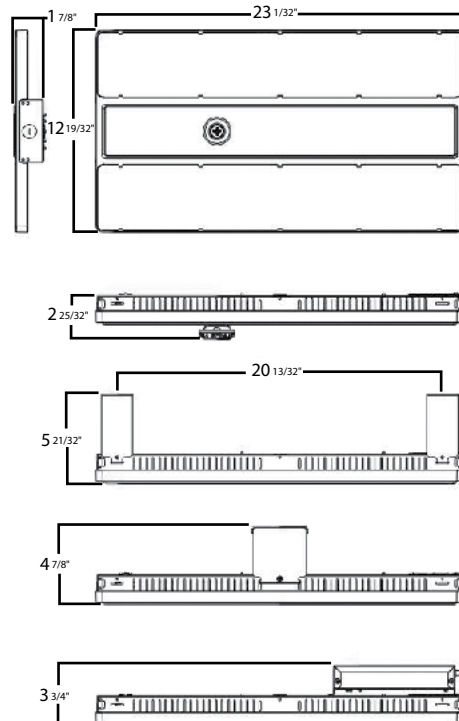

## ProLED Select Compact Linear High Bay Series Photometrics

### Luminous Intensity Distribution Curve

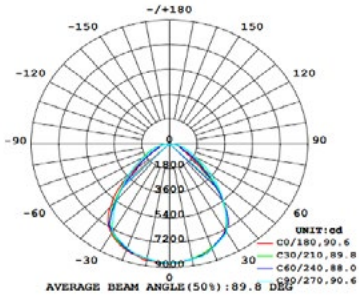

CLHB-1-WS-CS-U 5000K		
ZONE	LUMENS	% LAMP LUMENS
(0°-30°)	2917	19.6
(30°-60°)	3376	22.7
(60°-80°)	742	5
(80°-90°)	102	0.7
(0°-30°)	2968	19.9
(30°-60°)	3706	24.9
(60°-80°)	804	5.4
(80°-90°)	138	0.9
(90°-100°)	7	0
(100°-180°)	122	0.8

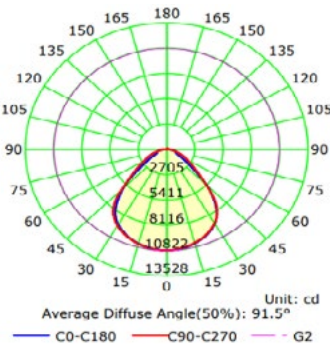

CLHB-2-WS-CS-U 5000K		
ZONE	LUMENS	% LAMP LUMENS
(0°-30°)	4208	17.7
(30°-60°)	5859	24.7
(60°-80°)	1247	5.3
(80°-90°)	166	0.7
(0°-30°)	4257	17.9
(30°-60°)	6260	26.4
(60°-80°)	1335	5.6
(80°-90°)	209	0.9
(90°-100°)	9	0
(100°-180°)	186	0.8

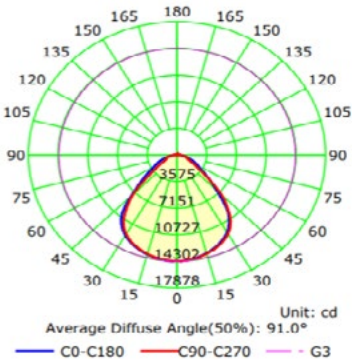

CLHB-3-WS-CS-U 5000K		
ZONE	LUMENS	% LAMP LUMENS
(0°-30°)	5588	18
(30°-60°)	7881	25.4
(60°-80°)	1678	5.4
(80°-90°)	241	0.8
(0°-30°)	5598	18
(30°-60°)	7883	25.4
(60°-80°)	1668	5.4
(80°-90°)	229	0.7
(90°-100°)	11	0
(100°-180°)	246	0.8

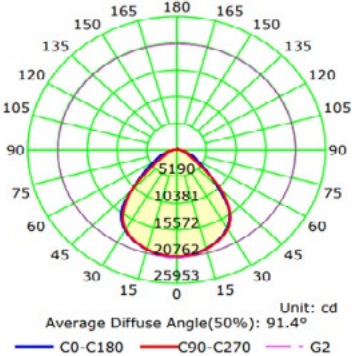

CLHB-4-WS-CS-U 5000K		
ZONE	LUMENS	% LAMP LUMENS
(0°-30°)	8107	17.9
(30°-60°)	11504	25.4
(60°-80°)	2410	5.3
(80°-90°)	325	0.7
(0°-30°)	8124	18
(30°-60°)	11626	25.7
(60°-80°)	2438	5.4
(80°-90°)	339	0.7
(90°-100°)	16	0
(100°-180°)	350	0.8

\*For complete photometry/IES files, please contact the factory. For all IES files please visit [halcolighting.com](http://halcolighting.com)

## ProLED Select Compact Linear High Bay Series

### Controls

#### Motion Sensor / PIR Sensor:

Product SKU	Product Code	Product Description
99986	LHB/MC	(0-10V) Motion Control Sensor LSXR 610 HL - Side Knockout Install

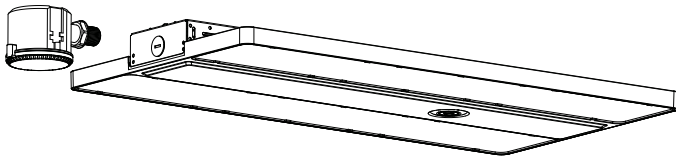

#### Wiring Instruction

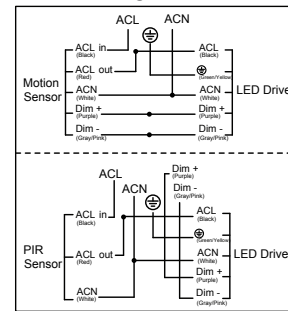

#### Motion Sensor / PIR Sensor:

Product SKU	Product Code	Product Description
24975	DCMSPIR	DC Bi-Level PIR (Passive Infrared) Motion Sensor, order minimum one remote (24876) per site
24875	DCMS	DC Bi-Level Motion Sensor, order minimum one remote (24876) per site
24876	DCMS-REM	DC Bi-Level Motion Sensor Remote

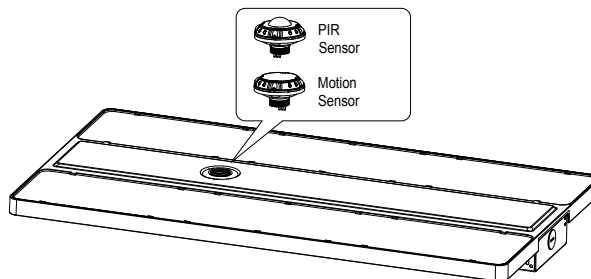



## ProLED Select Compact Linear High Bay Series

Wire Guard for CLHB-1

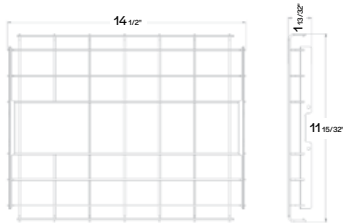

Pendant Mount for CLHB-1, CLHB-2

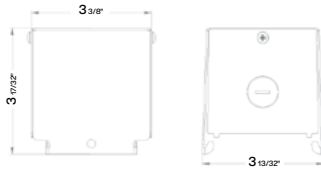

Surface Mount for CLHB-1, CLHB-2

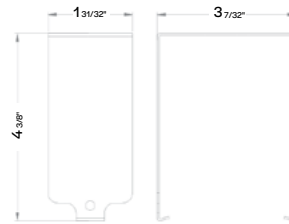

Wire Guard for CLHB-2

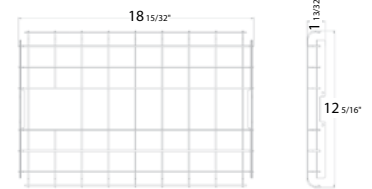

Pendant Mount for CLHB-3 CLHB-4



Surface Mount for CLHB-3 CLHB-4

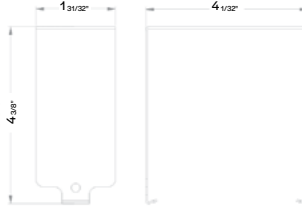

Wire Guard for CLHB-3, CLHB-4



## Accessories Ordering Information

Accessories purchased separately

Product SKU	Product Code	Product Description
36148	CLHB-1-A-WG	Wire Guard for CLHB-1
36149	CLHB-2-A-WG	Wire Guard for CLHB-2
36150	CLHB-34-A-WG	Wire Guard for CLHB-3, CLHB-4
36151	CLHB-12-M-PEND	Pendant Mount for CLHB-1, CLHB-2
36152	CLHB-12-M-SURF	Surface Mount for CLHB-1, CLHB-2
36153	CLHB-34-M-PEND	Pendant Mount for CLHB-3 CLHB-4
36154	CLHB-34-M-SURF	Surface Mount for CLHB-3 CLHB-4
36155	CLHB-BBU-9	Battery Backup (9W/90Min) for CLHB
36156	CLHB-12-DR-480V	Driver (150W) 277-480VAC for CLHB-1 CLHB-2
36157	CLHB-3-DR-480V	Driver (200W) 277-480VAC for CLHB-3
36158	CLHB-4-DR-480V	Driver (320W) 277-480VAC for CLHB-4

\*When using CLHB-BBU-9 or 16 and DCMS Motion Sensor, DCMS sensor must be set to ∞ standby time on the motion sensor remote. This setting allows fixture to not turn off in EM mode.