



# KT-LED10PLL-12GC-8XX-D

## PLL LED LAMP

### DESCRIPTION

10W PLL LED | 3000-5000K | >80 CRI | High-Efficiency



<b>LAMP TYPE:</b> PLL
<b>BASE TYPE:</b> 2G11
<b>WATTAGE:</b> 10W
<b>COLOR TEMPERATURE:</b> 3000-5000K
<b>COLOR RENDERING INDEX (CRI):</b> >80
<b>WARRANTY:</b> 5 Years

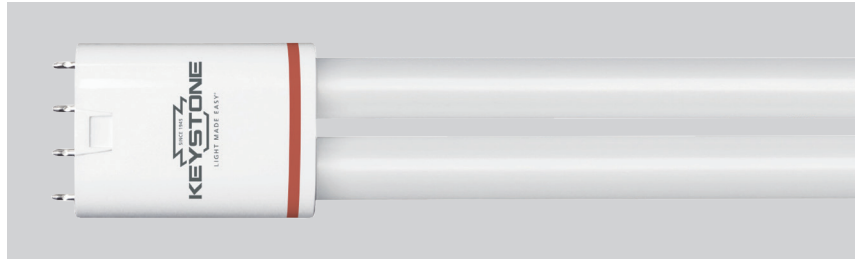

### PRODUCT FEATURES

- Replacement for conventional fluorescent lamp
- UL Classified
- 50,000+ hour lifetime
- Approximately 50% more energy efficient than standard FT24/2G11 lamps
- Environmentally friendly: No mercury used
- Integral driver (isolated) eliminates the need for an external ballast or driver
- Instant startup
- Not dimmable
- Frosted lens eliminates pixelation
- Operating temperature: -20°C/-4°F to 45°C/113°F
- 100+ Lumens per Watt (bare lamp efficacy)
- Suitable for dry and damp locations
- NSF Listed: NSF/ANSI Standard 2 - Food Equipment

### OPERATING SPECIFICATIONS

#### ELECTRICAL AND PERFORMANCE CHARACTERISTICS

Catalog Number	Input Voltage	CRI	Wattage	Nominal Lumens	Color Temp.	Beam Angle	Efficacy	Power Factor	Max. THD
KT-LED10PLL-12GC-830-D	120-277V	>80	10W	1200	3000K	160°	120 lm/W	>0.9	20%
KT-LED10PLL-12GC-835-D	120-277V	>80	10W	1200	3500K	160°	120 lm/W	>0.9	20%
KT-LED10PLL-12GC-840-D	120-277V	>80	10W	1250	4000K	160°	125 lm/W	>0.9	20%
KT-LED10PLL-12GC-850-D	120-277V	>80	10W	1250	5000K	160°	125 lm/W	>0.9	20%

### PHOTOMETRIC SPECIFICATIONS

#### ISOCANDELA PLOT

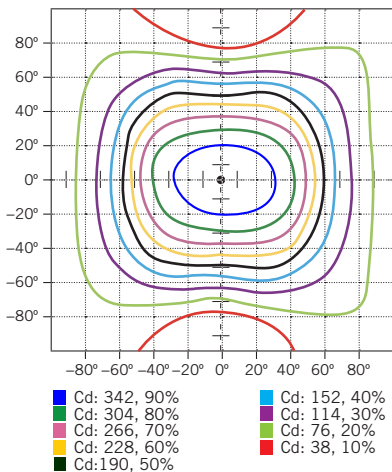

#### POLAR CANDELA DISTRIBUTION

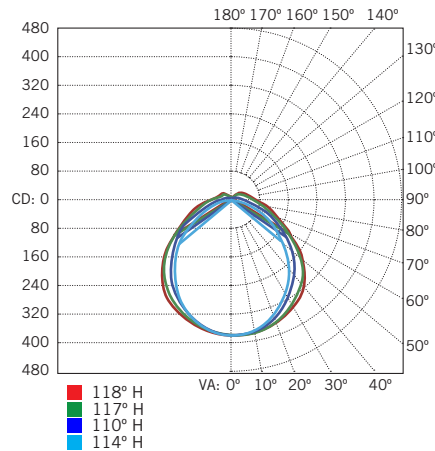

#### LUX DISTANCE CURVE

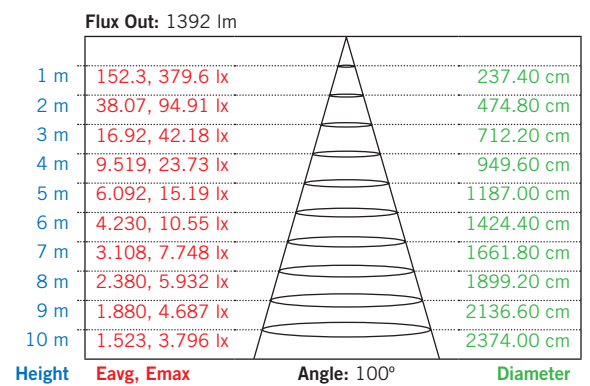

NOTE: Charts are represented by 5000K

**KT-LED10PLL-12GC-8XX-D**  
PLL LED LAMP

**WIRING DIAGRAMS**

1. Cut all existing connections to ballast as shown below and remove ballast.

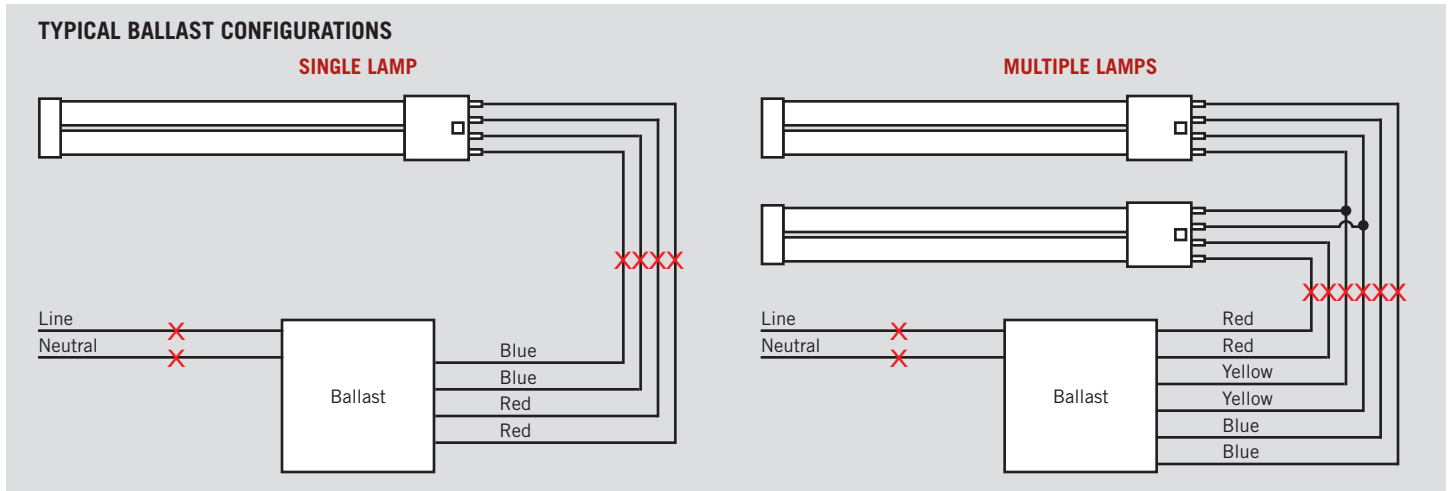

2. Re-wire fixture as shown below.

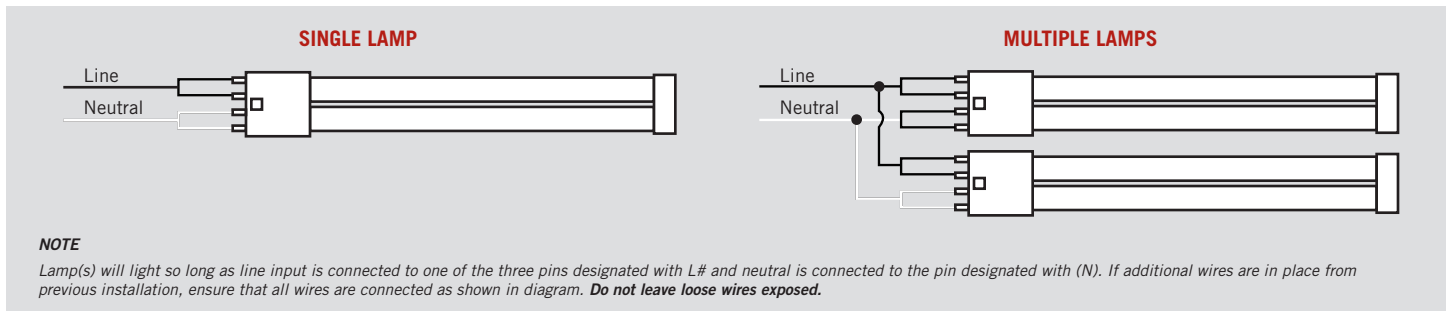

**PHYSICAL CHARACTERISTICS**

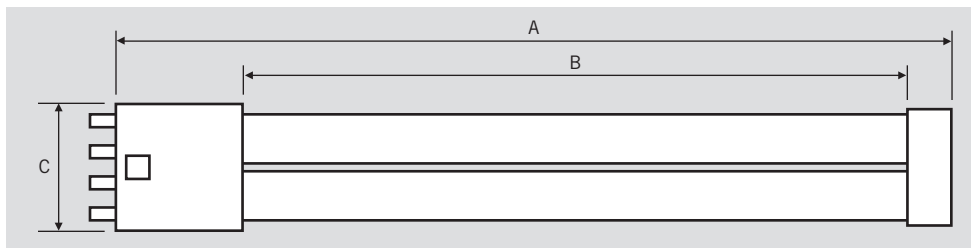

**LAMP DIMENSIONS**

A (Body Length)	12.2"
B (Illuminated Length)	9.3"
C (Width)	1.7"

**BASE TYPE: 2G11**



# KT-LED10PLL-12GC-8XX-D

## PLL LED LAMP

**ORDERING INFORMATION**

ORDER CODE	PACK QTY.	EASY CODE	UPC
KT-LED10PLL-12GC-830-D	24	HHU-66	843654131184
KT-LED10PLL-12GC-835-D	24	CGN-57	843654131191
KT-LED10PLL-12GC-840-D	24	JLG-84	843654131207
KT-LED10PLL-12GC-850-D	24	IBZ-37	843654131214

**CATALOG NUMBER BREAKDOWN**

# KT-LED10PLL-12GC-8XX-D

1
2
3
4
5
6
7
8
9

- 1** Keystone Technologies
- 2** LED Lamp
- 3** Wattage
- 4** Lamp Type
- 5** Nominal Length (Inches)
- 6** Glass
- 7** 800 Series
- 8** Color Temperature
- 9** Direct-Drive Series