

PRODUCT FEATURES

- ANSI Designation: M138 or M153
- Line Voltage: 120/208/240/277/480
- Regulation: 10%
- Frequency: 60 Hz
- Recommended Fuse (A): 8/5/5/3/3
- Circuit Type: CWA
- Insulation Class: 180°C
- Capacitor Value: 17 MF
- Capacitor Voltage Rating: 400 V
- Capacitor Temperature Rating: 90°C
- Winding Materials: Cu/Cu
- Lamp Starter: XG-04
- Agency Certification: RU, cRU
- Maximum Distance to Lamp: N/A
- 2 Year Warranty

LAMP TYPE: 250W MH-PS

INPUT VOLTAGE: 5 Tap (120/208/240/277/480)

CIRCUIT TYPE: CWA

ELECTRICAL SPECIFICATIONS

LINE VOLT (V)	POWER FACTOR	LINE CURRENT			INPUT POWER (W)	OPEN CIRCUIT VOLTAGE (V)	MINIMUM START TEMP	UL TEMP CODE	WIRING DIAGRAM
		OPERATING	OPEN	START					
120	High	2.43	2.32	1.51	284	281	-30°C	A	H9
208	High	1.41	1.38	0.85	284	281	-30°C	A	H9
240	High	1.22	1.17	0.77	284	281	-30°C	A	H9
277	High	1.06	1.03	0.66	284	281	-30°C	A	H9
480	High	0.60	0.60	0.38	284	281	-30°C	A	H9

WIRING DIAGRAMS

DIAGRAM H9

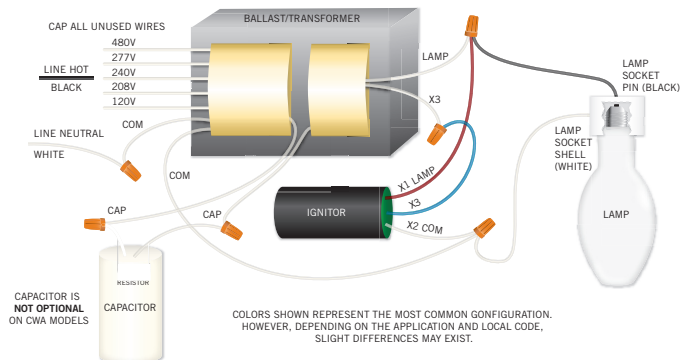
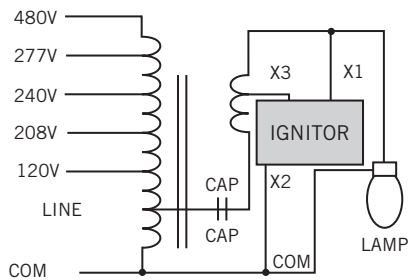

CASE STYLE/DIMENSIONS

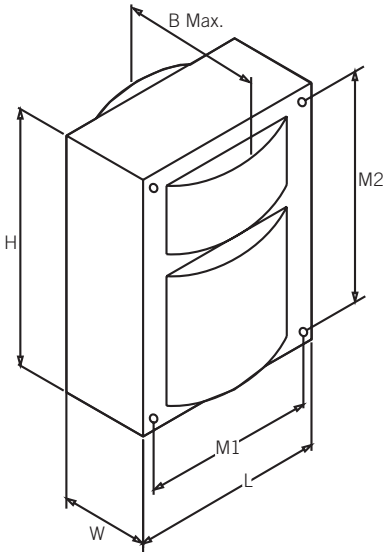

OVERALL DIMENSIONS

LENGTH: 4.25"
WIDTH: 1.52"
HEIGHT: 4.75"
B MAX: 3.93"

MOUNTING HOLES

DIAMETER: 0.25"
M1: 3.87"
M2: 4.83"

BRACKET DIMENSIONS

LENGTH: 7.25"
WIDTH: 1.11"

LEAD LENGTH: 12-14"

BALLAST NET WEIGHT: 9.92 lbs

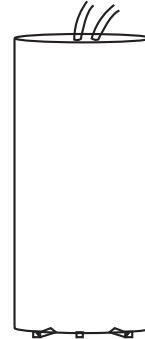

CAPACITOR INFO

WATTAGE: 250
MICROFARAD: 17
VOLTAGE: 400V
TYPE: Dry Film



IGNITOR INFO

LAMP TYPE: Pulse Start Metal Halide
WATTAGE: 250
TYPE:

ORDERING INFORMATION

ORDER CODE	PACKAGING STYLE	PACK QTY.	ITEM STATUS
MPS-250A-P-KIT		1	Quick Ship
*Kit Includes: Pre-Wired Ballast, Capacitor, Ignitor, Mounting Brackets, Mounting Hardware			

CATALOG NUMBER BREAKDOWN

MPS-250A-P-KIT

