



KT-RHLED-SM-3-KIT

STEEL SURFACE MOUNT KIT

DESCRIPTION

Steel Surface Mount Kit | Includes Mounting Hardware

APPLICATION

For use with 200W Round High Bay Fixture

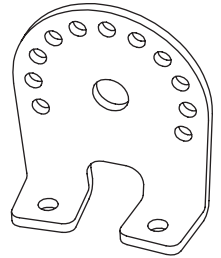
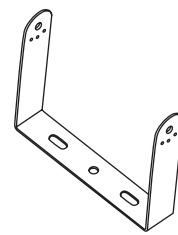

PHYSICAL SPECIFICATIONS

BRACKET A (x1)

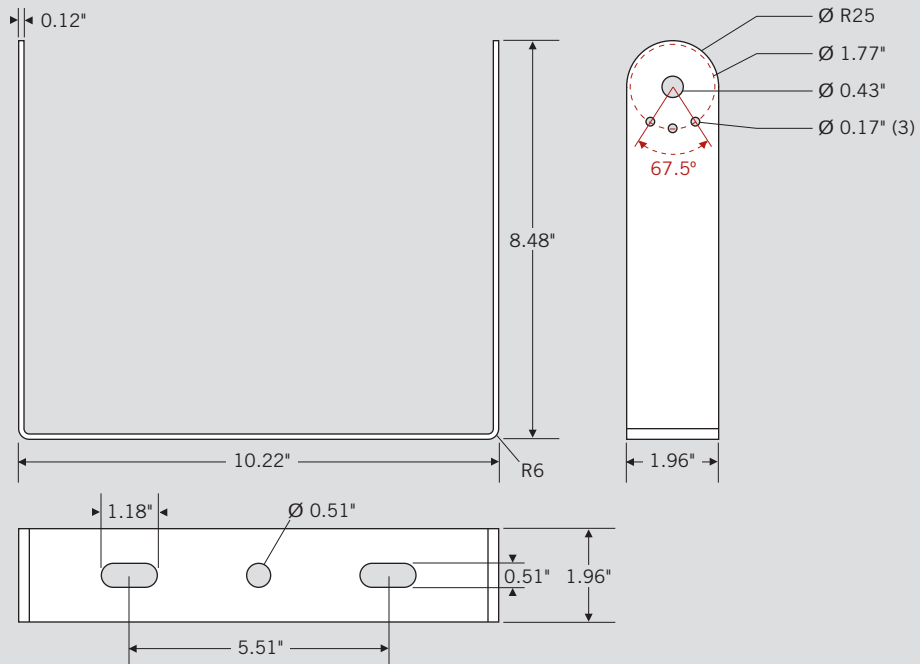

BRACKET B (x2)

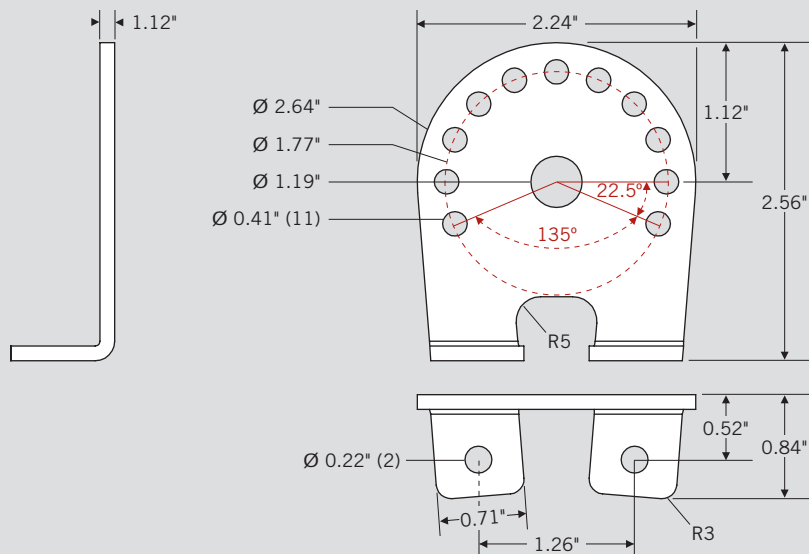



KT-RHLED-SM-3-KIT

STEEL SURFACE MOUNT KIT

INSTALLING MOUNTING BRACKETS

1. Attach two brackets B to the lamp using 4 screws provided.

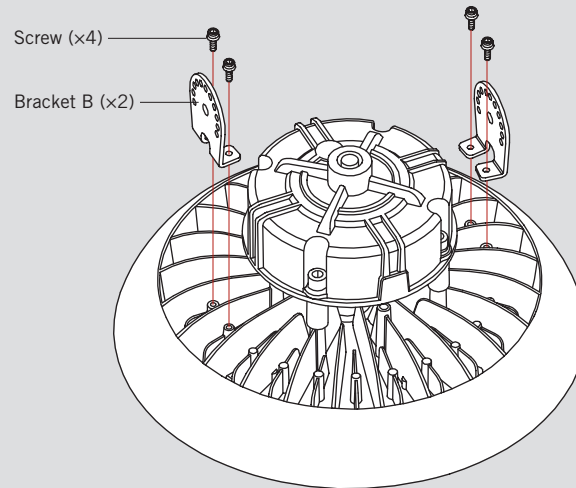

2. Attach bracket A to both brackets B using mounting hardware provided.

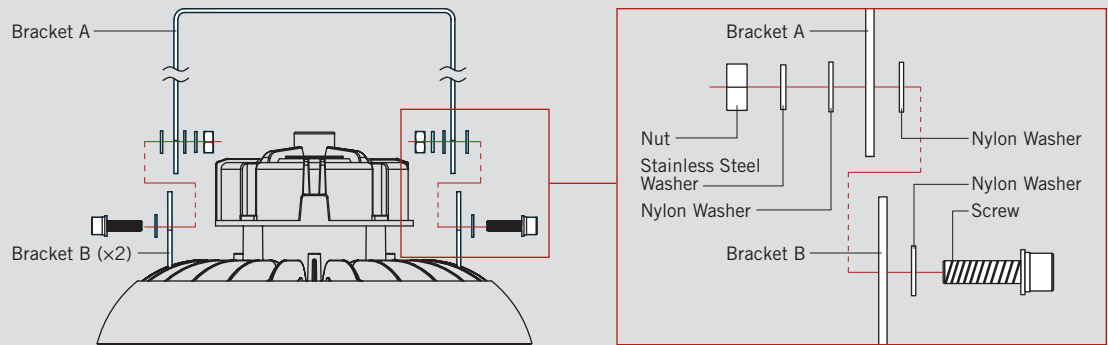

3. Adjust the angle of bracket A and then affix to each bracket B using mounting hardware provided.

