

SRK-LED-8-55-8XX

8' LED RETROFIT STRIP KIT



55W, 120-277V Input, 0-10V Dimming

DESCRIPTION: Upgrade Existing 8" Wide Strip Fixtures without Modifying the Existing Fixture Mounting; Narrow Profile

PRODUCT FEATURES

- Powered by 0-10V Dimming LED Drivers
- THD: <20%, Power Factor: >.90
- L70 > 50,000 Hour Lifetime
- Frosted Lens Eliminates Glare
- 0-10V Dimming, 10% Minimum
- Ambient Operating Temperature: -20°C/-4°F to 50°C/122°F
- Compatible with Emergency LED Drivers
- Eligible for DLC Multiple Listing



Catalog Number	Input Voltage	Wattage	Color Temperature	Lumen Output	CRI	Power Factor	Efficacy	Lifetime
SRK-LED-8-55-835	120-277V	55W	3500K	7150	>80	>0.9	130lm/W	50,000 Hours
SRK-LED-8-55-840	120-277V	55W	4000K	7260	>80	>0.9	132lm/W	50,000 Hours
SRK-LED-8-55-850	120-277V	55W	5000K	7370	>80	>0.9	134lm/W	50,000 Hours

SRK-LED-8-55-8XX

8' LED RETROFIT STRIP KIT

PHYSICAL SPECIFICATIONS

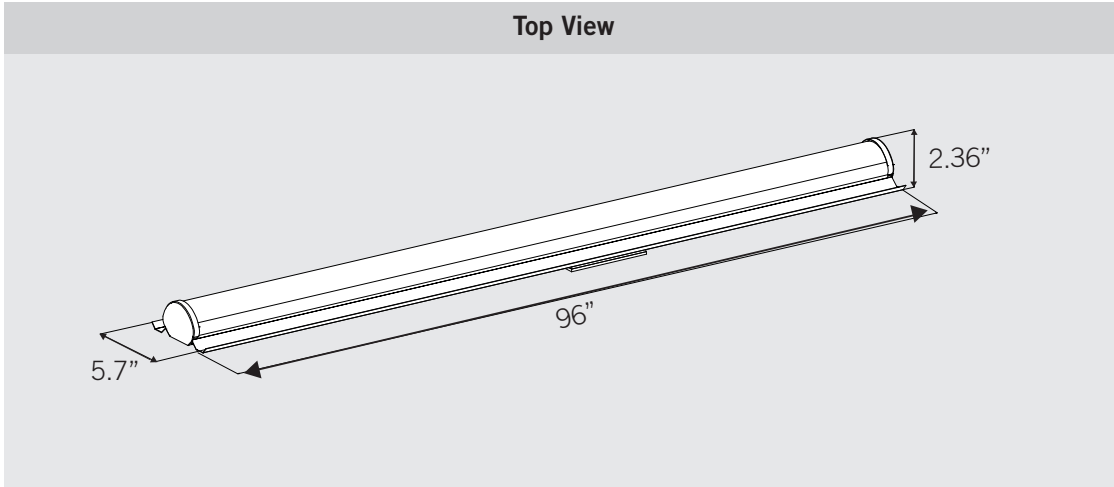

COMPONENT SUMMARY

Part	Qty.
Retrofit housing	1
Installation Bracket	2
Installation Instruction	1
Lens	1
Label	1