

# WP-LED-TM-35-8CSB

## TRADITIONAL 35W NON-CUTOFF LED WALL PACK



Traditional 35W, 120-277V Input

### PRODUCT FEATURES

- Traditional design matches appearance and light distribution pattern of legacy HID, optimized for one-for-one replacements
- Heavy-duty, die-cast aluminum housing with (5) available 1/2" threaded conduit hubs: (1) on back and (1) on all four sides
- Powered by 0–10V dimming LED drivers
- CCT Selection: Adjustable CCT (3000K, 4000K, or 5000K)
- Built-in dusk-to-dawn photocell behind translucent 3/4" threaded plug with anti-yellowing agent
- Borosilicate glass lens diffuses light source and provides uniform distribution
- Covers footprint of mid-size HID wallpacks
- Ambient operating temperature: –40°C/–40°F to 50°C/122°F
- UL listed for wet locations, IP65
- 0–10V dimming, 10% min
- Power Factor: >0.95
- THD: <20%
- LED chip lifetime: L70 >100,000 hrs @ 25°C/77°F ambient fixture temp
- Meets FCC Part 15, Part B, Class A standards for conducted and radiated emissions
- Fixture impact rating IK06
- Compatible with LED Emergency Backups



### ELECTRICAL SPECIFICATIONS

Catalog Number	Wattage	Lumens	Lumens Below 90°	Dimming	CCT*	Efficacy	CRI	Housing Color	Input Voltage	Rated Life	Legacy Equivalent
WP-LED-TM-35-8CSB	35W	4885 lm	4400 lm	0–10V	3000K	140 lm/W	>80	Bronze	120–277V	50,000 hrs	150W MH
		5460 lm	4910 lm		4000K	156 lm/W					
		5010 lm	4505 lm		5000K	143 lm/W					

\* Color Uniformity: CCT (Correlated Color Temperature) range as per guidelines outlined in ANSI C78.377-2017

# WP-LED-TM-35-8CSB

## TRADITIONAL 35W NON-CUTOFF LED WALL PACK

### PHOTOMETRIC SPECIFICATIONS

#### ISOCANDELA PLOT

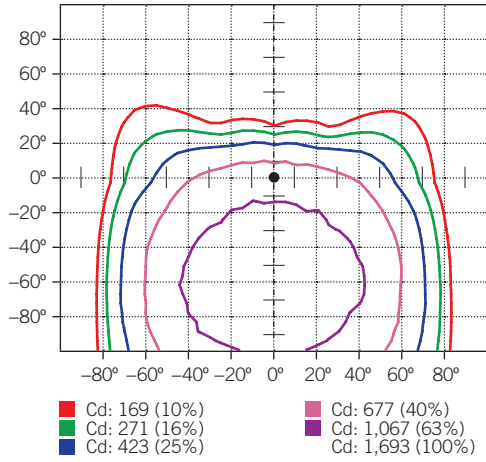

#### LUMINOUS INTENSITY DISTRIBUTION

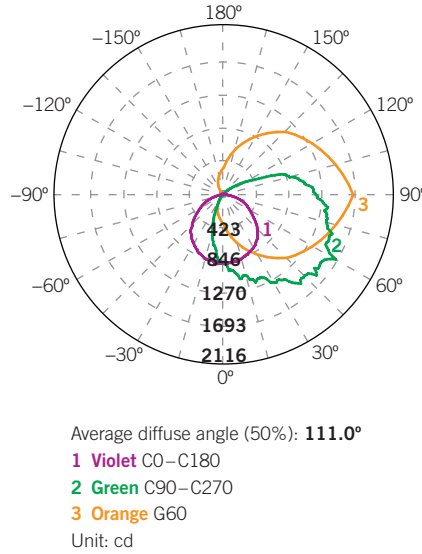

#### FLUX DISTRIBUTION

Zone	Lumens	% Luminaire
<b>Forward Light</b>	3,845 lm	79.5%
0°-30°	591 lm	12.2%
30°-60°	1,673 lm	34.6%
60°-80°	1,166 lm	24.1%
80°-90°	416 lm	8.6%
<b>Back Light</b>	507 lm	10.5%
0°-30°	210 lm	4.4%
30°-60°	227 lm	4.7%
60°-80°	59 lm	1.2%
80°-90°	10 lm	0.2%
<b>Up Light</b>	481 lm	9.9%
90°-100°	215 lm	4.4%
100°-180°	267 lm	5.5%

BUG* Rating	
Asymmetrical Luminaire Types	
Type I, II, III, IV	B1 U3 G3
Quadrilateral Symmetrical Luminaire Types	
Type V, Area Light	B1 U3 G3

\* Backlight, Uplight, Glare

#### MOUNTING

Side view

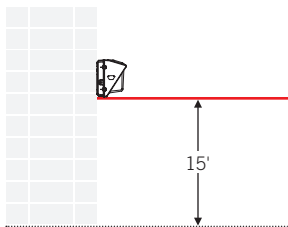

#### LIGHT DISTRIBUTION PATTERN

Isometric view from above; Luminaire mounted at 15'

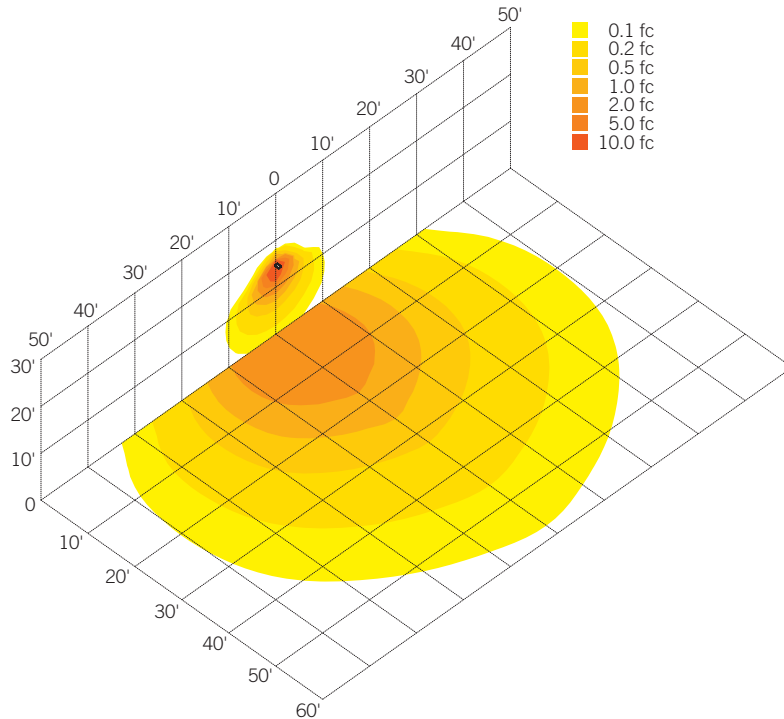

# WP-LED-TM-35-8CSB

## TRADITIONAL 35W NON-CUTOFF LED WALL PACK

### PHYSICAL SPECIFICATIONS

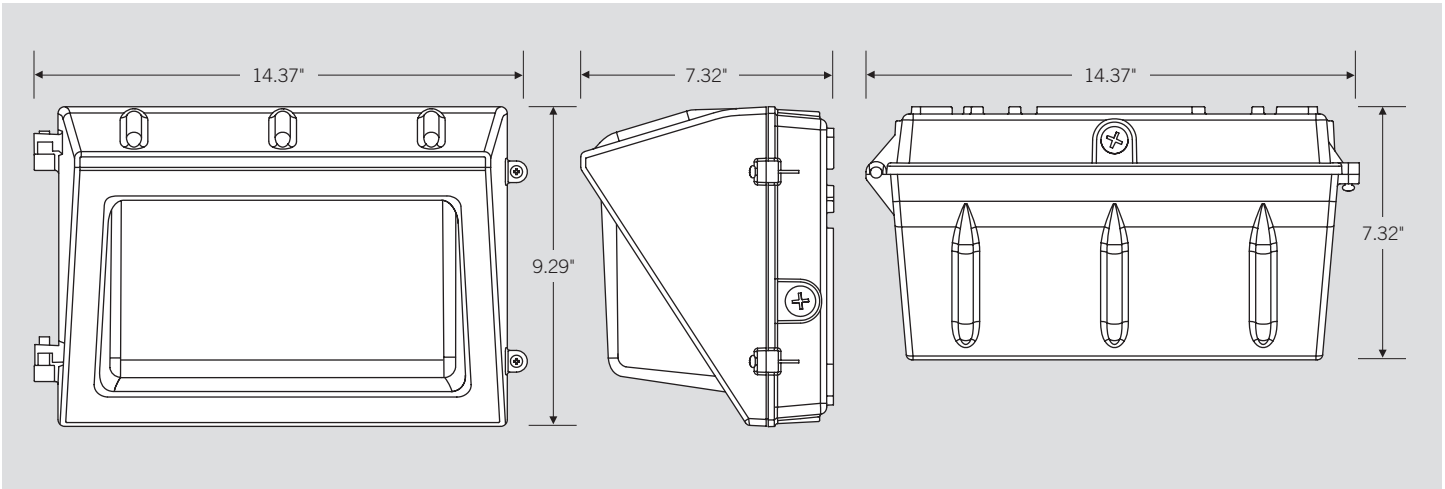

### GENERAL SETUP INSTRUCTIONS

#### GENERAL WIRING DIAGRAM

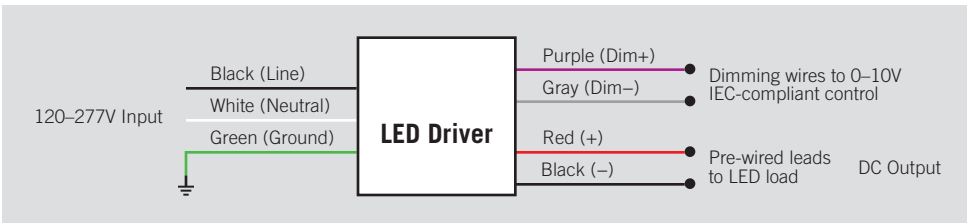

**Caution:** Before installing, make certain that AC power to the fixture is off.

**Caution:** The electrical rating of this product is 120-277V. Installer must confirm that there is 120-277V at the fixture before installation.

#### PHOTOCELL ENABLE/DISABLE

This fixture is equipped with a dusk-to-dawn photocell behind the translucent knock-out (KO) cover. Adjust the dip switch to enable (ON) or disable (OFF) the photocell function (see illustrations to the right). Fixture comes preset with photocell enabled unless otherwise noted.

#### (CCT) ADJUSTMENT

This fixture is equipped with CCT Selection. There is an adjustable dip switch behind the translucent knock-out (KO) cover to change CCT between 5000K, 4000K, and 3000K (see illustrations to the right). Fixture comes preset at 5000K unless otherwise noted.

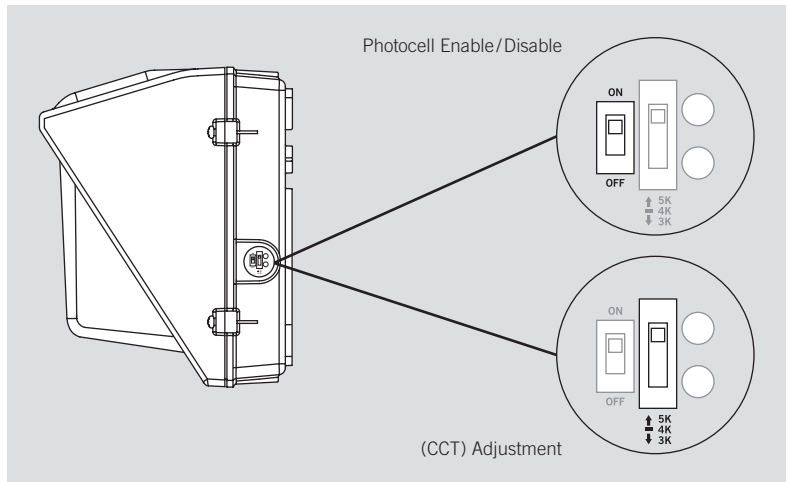

### ORDERING INFORMATION

CATALOG NUMBER	PACK QTY.	UPC
WP-LED-TM-35-8CSB	1	843654133577