

WP-LED-TM-55-8CSB

TRADITIONAL 55W NON-CUTOFF LED WALL PACK



Traditional 55W, 120-277V Input

PRODUCT FEATURES

- Traditional design matches appearance and light distribution pattern of legacy HID, optimized for one-for-one replacements
- Heavy-duty, die-cast aluminum housing with (5) available 1/2" threaded conduit hubs: (1) on back and (1) on all four sides
- Powered by 0–10V dimming LED drivers
- CCT Selection: Adjustable CCT (3000K, 4000K, or 5000K)
- Built-in dusk-to-dawn photocell behind translucent 3/4" threaded plug with anti-yellowing agent
- Borosilicate glass lens diffuses light source and provides uniform distribution
- Covers footprint of mid-size HID wallpacks
- Ambient operating temperature: –40°C/–40°F to 50°C/122°F
- UL listed for wet locations, IP65
- 0–10V dimming, 10% min
- Power Factor: >0.95
- THD: <20%
- LED chip lifetime: L70 >100,000 hrs @ 25°C/77°F ambient fixture temp
- Meets FCC Part 15, Part B, Class A standards for conducted and radiated emissions
- Fixture impact rating IK06
- Compatible with LED Emergency Backups



ELECTRICAL SPECIFICATIONS

Catalog Number	Wattage	Lumens	Lumens Below 90°	Dimming	CCT*	Efficacy	CRI	Housing Color	Input Voltage	Rated Life	Legacy Equivalent
WP-LED-TM-55-8CSB	55W	7200 lm	6480 lm	0–10V	3000K	131 lm/W	>80	Bronze	120–277V	50,000 hrs	175–250W MH
		7690 lm	6895 lm		4000K	140 lm/W					
		7450 lm	6705 lm		5000K	135 lm/W					

* Color Uniformity: CCT (Correlated Color Temperature) range as per guidelines outlined in ANSI C78.377-2017

WP-LED-TM-55-8CSB

TRADITIONAL 55W NON-CUTOFF LED WALL PACK

PHOTOMETRIC SPECIFICATIONS

ISOCANDELA PLOT

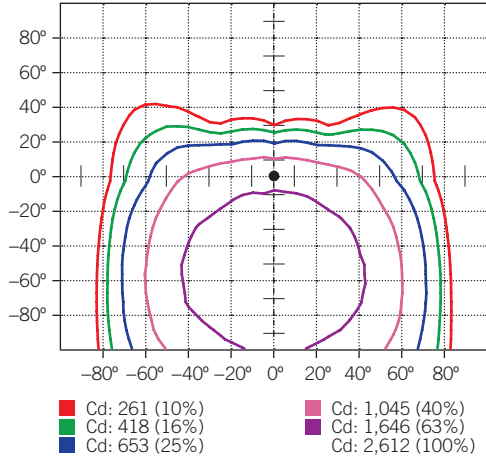

LUMINOUS INTENSITY DISTRIBUTION

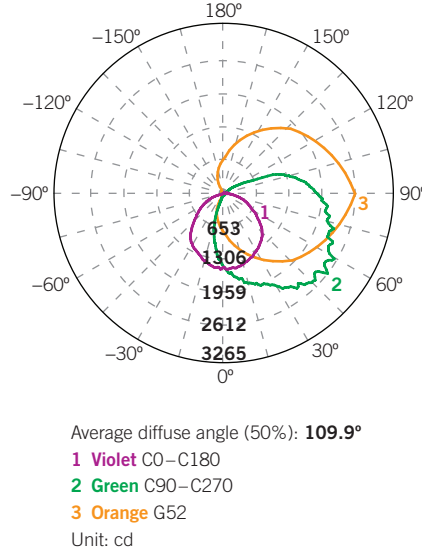

FLUX DISTRIBUTION

Zone	Lumens	% Luminaire
Forward Light	6,006 lm	81.9%
0°-30°	734 lm	10.0%
30°-60°	2,633 lm	35.9%
60°-80°	1,981 lm	27.0%
80°-90°	658 lm	9.0%
Back Light	629 lm	8.6%
0°-30°	241 lm	3.3%
30°-60°	294 lm	4.0%
60°-80°	80 lm	1.1%
80°-90°	15 lm	0.2%
Up Light	691 lm	9.5%
90°-100°	313 lm	4.3%
100°-180°	378 lm	5.2%

BUG* Rating	
Asymmetrical Luminaire Types	
Type I, II, III, IV	B1 U3 G4
Quadrilateral Symmetrical Luminaire Types	
Type V, Area Light	B1 U3 G4

MOUNTING

Side view

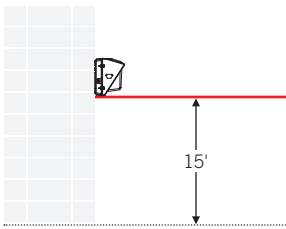

LIGHT DISTRIBUTION PATTERN

Isometric view from above; Luminaire mounted at 15'

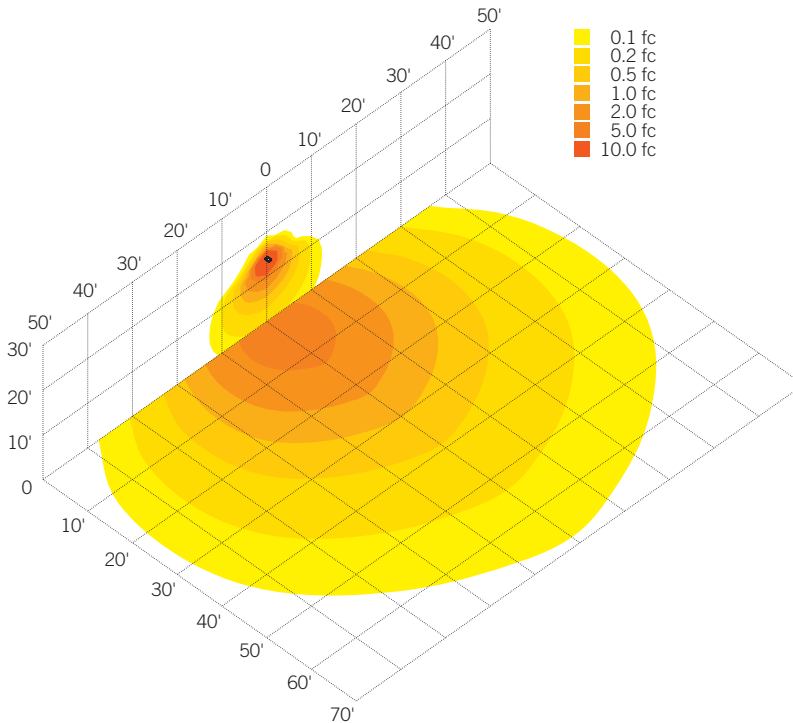

* Backlight, Uplight, Glare

WP-LED-TM-55-8CSB

TRADITIONAL 55W NON-CUTOFF LED WALL PACK

PHYSICAL SPECIFICATIONS

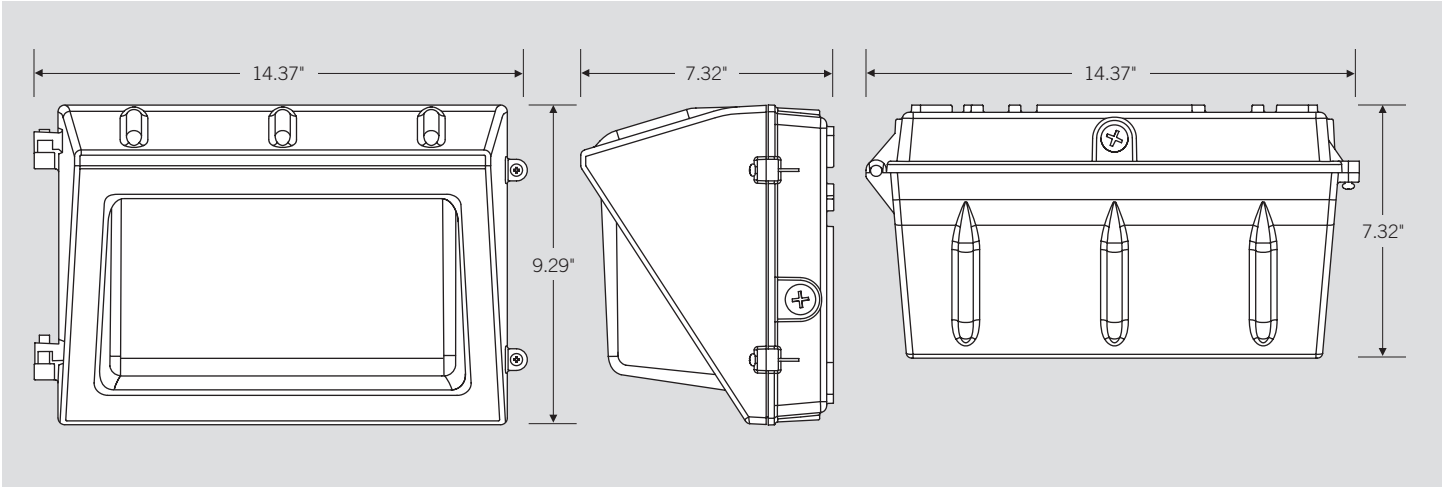

GENERAL SETUP INSTRUCTIONS

GENERAL WIRING DIAGRAM

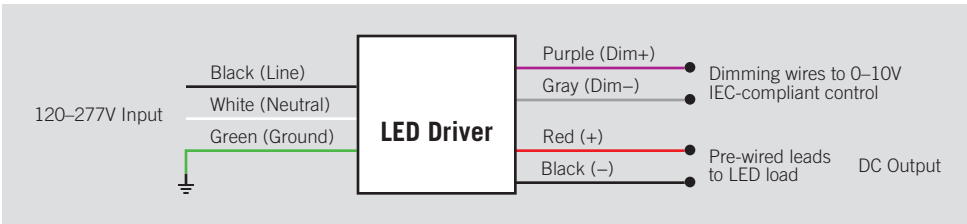

Caution: Before installing, make certain that AC power to the fixture is off.

Caution: The electrical rating of this product is 120–277V. Installer must confirm that there is 120–277V at the fixture before installation.

PHOTOCELL ENABLE/DISABLE

This fixture is equipped with a dusk-to-dawn photocell behind the translucent knock-out (KO) cover. Adjust the dip switch to enable (ON) or disable (OFF) the photocell function (see illustrations to the right). Fixture comes preset with photocell enabled unless otherwise noted.

(CCT) ADJUSTMENT

This fixture is equipped with CCT Selection. There is an adjustable dip switch behind the translucent knock-out (KO) cover to change CCT between 5000K, 4000K, and 3000K (see illustrations to the right). Fixture comes preset at 5000K unless otherwise noted.

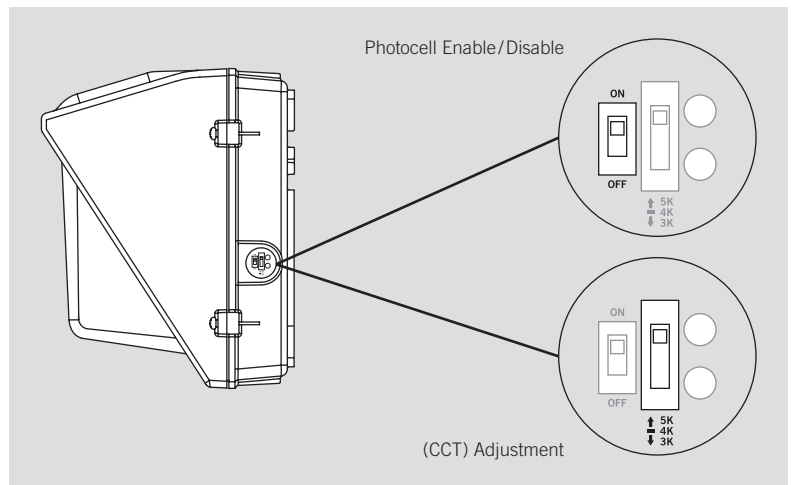

ORDERING INFORMATION

CATALOG NUMBER	PACK QTY.	UPC
WP-LED-TM-55-8CSB	1	843654133584