



KT-WPLED100-M2-8XX-VDIM

ARCHITECTURAL 100W FULL-CUTOFF LED WALL PACK

DESCRIPTION

Architectural 100W Full-Cutoff LED Wall Pack | 120–277V Input | 4000–5000K | Medium-Size Bronze Housing | Wide Optic Lens

APPLICATION

Building Mount for exterior illumination (perimeters, pathways, loading docks, and other general security lighting requirements)

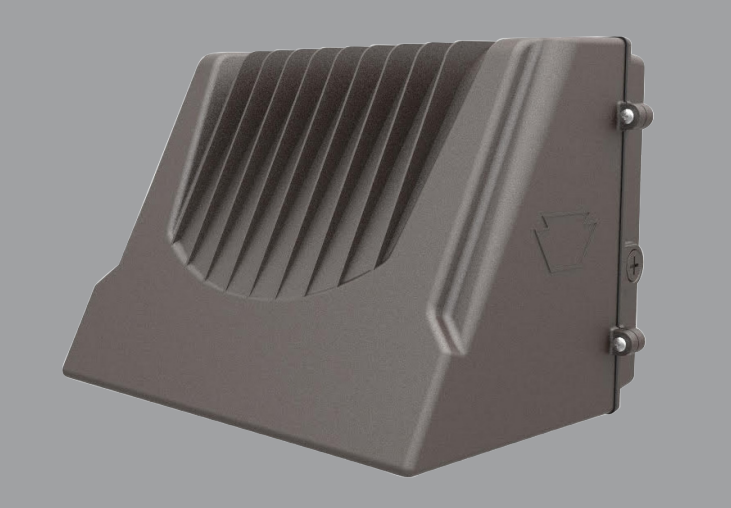

PRODUCT FEATURES

- Architectural full-cutoff design improves the appearance of building exteriors and optimizes functional light distribution
- Heavy-duty, die-cast aluminum housing features modern aesthetics while retaining (5) available 1/2" threaded conduit hubs: (1) on back and (1) on all four sides
- Powered by Keystone 0–10V dimming LED drivers
- Dark Sky friendly performance, eliminates undesirable sky glow and glare
- Features one translucent 3/4" threaded plug with anti-yellowing agent for use with photocell accessory KT-WPLED-PS-UV-KO
- Precision-crafted optical lens provides wide distribution pattern ideal for increased fixture spacing and uniformity
- Covers footprint of mid-size HID wallpacks
- Ambient operating temperature: –20°C/–4°F to 45°C/113°F
- UL listed for wet locations, IP65
- 0–10V dimming, 10% min
- Power Factor: >0.95
- THD: <20%
- LED chip lifetime: L70 >100,000 hrs @ 25°C/77°F ambient fixture temp
- Meets FCC Part 15, Part B, Class A standards for conducted and radiated emissions

ELECTRICAL SPECIFICATIONS

Catalog Number	Wattage	Lumens	Lumens Below 90°	Dimming	CCT	Efficacy	CRI	Housing Color	Input Voltage	Rated Life	Legacy Equivalent
KT-WPLED100-M2-840-VDIM	100W	12500 lm	12410 lm	0–10V	4000K	125 lm/W	>80	Bronze	120–277V	50,000 hrs	400W MH
KT-WPLED100-M2-850-VDIM		13000 lm	12900 lm		5000K	130 lm/W					

KT-WPLED100-M2-8XX-VDIM
ARCHITECTURAL 100W FULL-CUTOFF LED WALL PACK

PHOTOMETRIC SPECIFICATIONS

ISOCANDELA PLOT

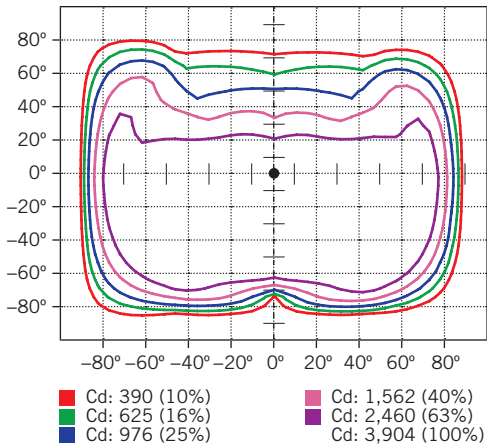

LUMINOUS INTENSITY DISTRIBUTION

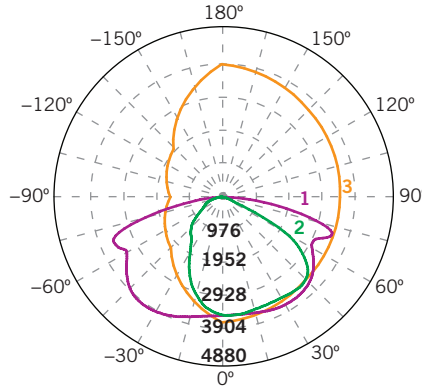

Average diffuse angle (50%): **124.7°**

FLUX DISTRIBUTION

Zone	Lumens	% Luminaire
Forward Light	8,446 lm	64.1%
0°-30°	1,534 lm	11.6%
30°-60°	4,104 lm	31.1%
60°-80°	2,553 lm	19.4%
80°-90°	255 lm	1.9%
Back Light	4,633 lm	35.1%
0°-30°	1,263 lm	9.6%
30°-60°	2,156 lm	16.4%
60°-80°	1,094 lm	8.3%
80°-90°	119 lm	0.9%
Up Light	102 lm	0.8%
90°-100°	13 lm	0.1%
100°-180°	89 lm	0.7%

BUG* Rating	
Asymmetrical Luminaire Types	
Type I, II, III, IV	B3 U5 G3
Quadrilateral Symmetrical Luminaire Types	
Type V, Area Light	B3 U5 G2

* Backlight, Uplight, Glare

MOUNTING

Side view

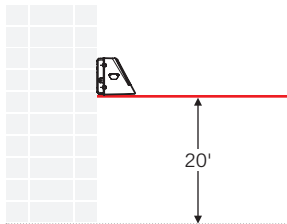

LIGHT DISTRIBUTION PATTERN

Isometric view from above; Luminaire mounted at 20°

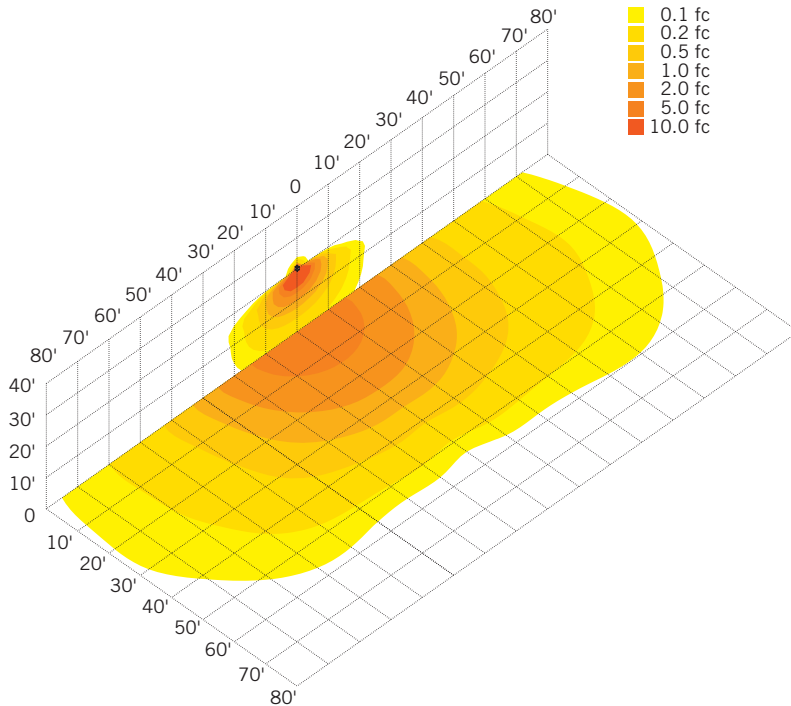



KT-WPLED100-M2-8XX-VDIM

ARCHITECTURAL 100W FULL-CUTOFF LED WALL PACK

PHYSICAL SPECIFICATIONS

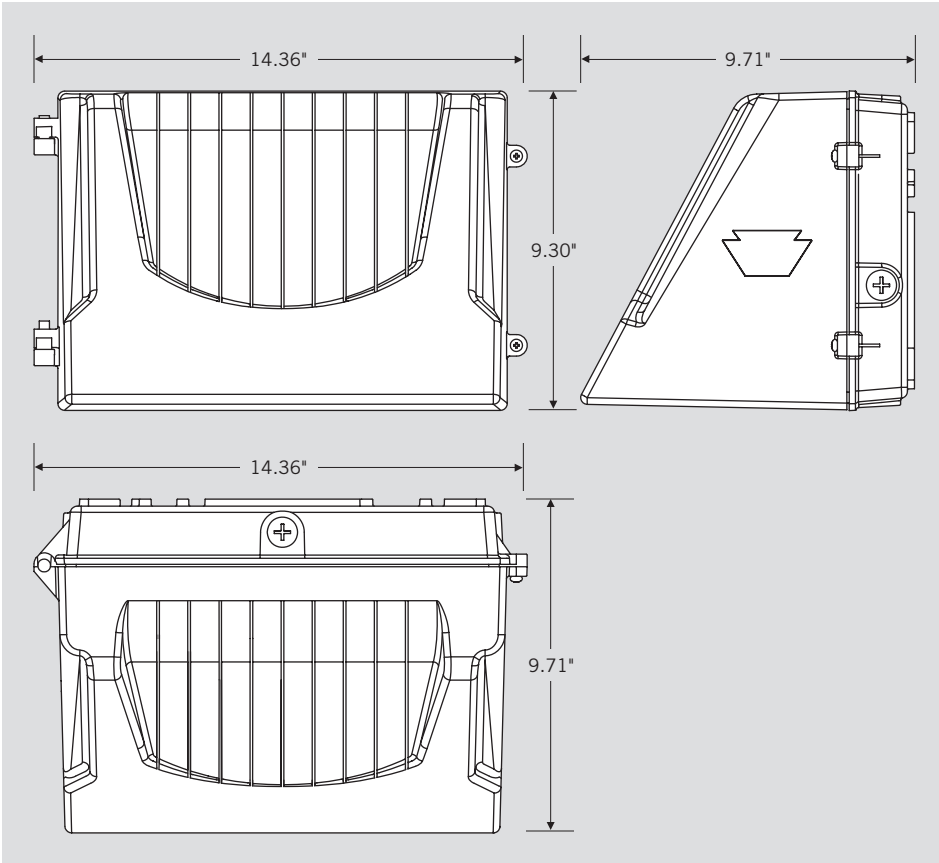

GENERAL SETUP INSTRUCTIONS

GENERAL WIRING DIAGRAM

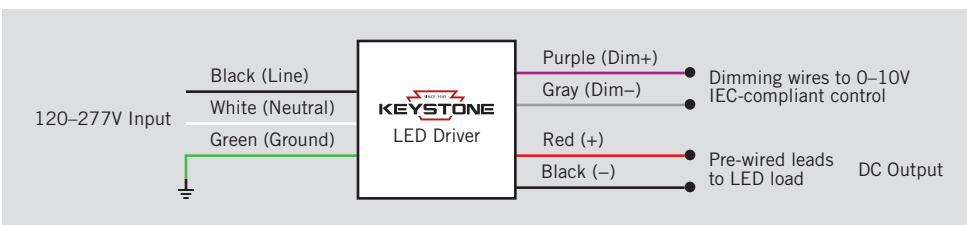

Caution: Before installing, make certain that AC power to the fixture is off.

Caution: The electrical rating of this product is 120-277V. Installer must confirm that there is 120-277V at the fixture before installation.



KT-WPLED100-M2-8XX-VDIM

ARCHITECTURAL 100W FULL-CUTOFF LED WALL PACK

ACCESSORIES (SOLD SEPARATELY)

Catalog Number	Description
KTSP-10KV-C	Wallpack 10kV Surge Protector, Compact Design
KT-WPLED-PS-UV-KO	Keystone Wall Pack Button Photocell

ORDERING INFORMATION

ORDER CODE	PACK QTY.	ITEM STATUS
KT-WPLED100-M2-840-VDIM	1	Quick Ship
KT-WPLED100-M2-850-VDIM	1	Quick Ship

CATALOG NUMBER BREAKDOWN

KT-WPLED100-M2-8XX-VDIM

1	2	3	4	5	6	7	8	9																						
<p>1 Keystone Technologies</p> <p>2 Fixture Type</p> <p>3 LED Lamp</p> <p>4 Max Wattage</p> <p>5 Size</p> <p>6 Style</p> <p>7 CRI</p> <p>8 Color</p> <p>9 Dimming</p>	<p>2 Fixture Type</p> <table border="1" style="width: 100%; border-collapse: collapse;"> <tr> <td style="width: 20%; text-align: center;">F</td> <td>Flood</td> </tr> <tr> <td style="text-align: center;">WP</td> <td>Wallpack</td> </tr> </table>	F	Flood	WP	Wallpack	<p>5 Size</p> <table border="1" style="width: 100%; border-collapse: collapse;"> <tr> <td style="width: 20%; text-align: center;">S</td> <td>Small</td> </tr> <tr> <td style="text-align: center;">M</td> <td>Medium</td> </tr> <tr> <td style="text-align: center;">L</td> <td>Large</td> </tr> </table>	S	Small	M	Medium	L	Large	<p>6 Style</p> <table border="1" style="width: 100%; border-collapse: collapse;"> <tr> <td style="width: 20%; text-align: center;">1</td> <td>Non-Cutoff</td> </tr> <tr> <td style="text-align: center;">2</td> <td>Full-Cutoff</td> </tr> </table>	1	Non-Cutoff	2	Full-Cutoff	<p>7 CRI</p> <table border="1" style="width: 100%; border-collapse: collapse;"> <tr> <td style="width: 20%; text-align: center;">8</td> <td>>80</td> </tr> <tr> <td style="text-align: center;">9</td> <td>>90</td> </tr> </table>	8	>80	9	>90	<p>8 Color</p> <table border="1" style="width: 100%; border-collapse: collapse;"> <tr> <td style="width: 20%; text-align: center;">40</td> <td>4000K</td> </tr> <tr> <td style="text-align: center;">50</td> <td>5000K</td> </tr> </table>	40	4000K	50	5000K	<p>9 Dimming</p> <table border="1" style="width: 100%; border-collapse: collapse;"> <tr> <td style="width: 20%; text-align: center;">VDIM</td> <td>0-10V</td> </tr> </table>	VDIM	0-10V
F	Flood																													
WP	Wallpack																													
S	Small																													
M	Medium																													
L	Large																													
1	Non-Cutoff																													
2	Full-Cutoff																													
8	>80																													
9	>90																													
40	4000K																													
50	5000K																													
VDIM	0-10V																													