

Project
Schedule / Date
Notes
Catalog Number

### Slim Area Light

#### Product Description

Our naturaLED® Slim Area Light is constructed with a durable, die-cast aluminum housing and excellent thermal design and is the perfect lighting solution for your parking lot, street, walkway, building flood up/down light and/or as a sign lighter. It provides uniform, consistent color with a wide range of wattage selections to replace from 50W to 1500W HID fixtures.

Our fixtures are DLC Premium certified and IP65 rated with five types of mounting options available: Swivel Bracket, Slip Fitter, Yoke, 6" Extruded Arm and Pendant Mount. Compatible integrated autonomous and photocell motion sensors are available as options to address your needs.

Energy savings can be as much as 85% while eliminating maintenance costs in labor and lamp and ballast replacement.



#### Features & Benefits

- ▶ DLC Premium
- ▶ IP65 Rated
- ▶ Uniform and Consistent color
- ▶ Optimized Thermal Design
- ▶ Minimize Glare
- ▶ Select Binning for Color Consistency
- ▶ Aluminum Die-cast Housing
- ▶ Finish: Epoxy Powder Coat

#### Specifications

- ▶ Input line voltage: 120-277 / 277-480
- ▶ 0-10V Dimming
- ▶ L90-100,000 hours rated chips
- ▶ Powerfactor >0.9
- ▶ Available in Type 3 and Type 5 Light Distribution
- ▶ Operating temperature: -40°F ~ 122°F

#### Applications

- ▶ Parking Lot Lighting
- ▶ Street Lighting
- ▶ Site Lighting
- ▶ Streetscape Lighting
- ▶ Area Lighting

#### Color Choices



#### Accessories (Mounting Options)

- ▶ Slip Fitter
- ▶ Swivel Bracket
- ▶ 6" Extended Arm
- ▶ Pendant Mount
- ▶ Yoke Mount



Ordering Information (120-277V)

Code	Description	CCT	Watt	Lumen	Equiv Wattage	Voltage	Beam Angle	Color	Rated Hrs	IP 65	DLC
7616	LED-FXSAL29/40K/DB/3S	4000K	29	3,517	100-150	120-277	Type 3	D.Bronze	50,000	•	•
7617	LED-FXSAL29/50K/DB/3S	5000K	29	3,576	100-150	120-277	Type 3	D.Bronze	50,000	•	•
7618	LED-FXSAL29/40K/WH/3S	4000K	29	3,517	100-150	120-277	Type 3	White	50,000	•	•
7619	LED-FXSAL29/50K/WH/3S	5000K	29	3,576	100-150	120-277	Type 3	White	50,000	•	•
7620	LED-FXSAL50/40K/DB/3S	4000K	50	6,241	250	120-277	Type 3	D.Bronze	50,000	•	•
7621	LED-FXSAL50/50K/DB/3S	5000K	50	6,247	250	120-277	Type 3	D.Bronze	50,000	•	•
7622	LED-FXSAL50/40K/WH/3S	4000K	50	6,241	250	120-277	Type 3	White	50,000	•	•
7623	LED-FXSAL50/50K/WH/3S	5000K	50	6,247	250	120-277	Type 3	White	50,000	•	•
7752	LED-FXSAL75/30K/DB/3S	3000K	75	8,250	150-250	120-277	Type 3	D.Bronze	50,000	•	
7624	LED-FXSAL75/40K/DB/3S	4000K	75	8,738	250-400	120-277	Type 3	D.Bronze	50,000	•	•
7625	LED-FXSAL75/50K/DB/3S	5000K	75	9,011	250-400	120-277	Type 3	D.Bronze	50,000	•	•
7753	LED-FXSAL75/30K/WH/3S	3000K	75	8,250	150-250	120-277	Type3	White	50,000	•	
7626	LED-FXSAL75/40K/WH/3S	4000K	75	8,738	250-400	120-277	Type 3	White	50,000	•	•
7627	LED-FXSAL75/50K/WH/3S	5000K	75	9,011	250-400	120-277	Type 3	White	50,000	•	•
7754	LED-FXSAL100/30K/DB/3S	3000K	100	11,000	250-320	120-277	Type3	D.Bronze	50,000	•	
7628	LED-FXSAL100/40K/DB/3S	4000K	100	11,548	400	120-277	Type 3	D.Bronze	50,000	•	•
7629	LED-FXSAL100/50K/DB/3S	5000K	100	11,821	400	120-277	Type 3	D.Bronze	50,000	•	•
7755	LED-FXSAL100/30K/WH/3S	3000K	100	11,000	250-320	120-277	Type 3	White	50,000	•	
7630	LED-FXSAL100/40K/WH/3S	4000K	100	11,548	400	120-277	Type 3	White	50,000	•	•
7631	LED-FXSAL100/50K/WH/3S	5000K	100	11,821	400	120-277	Type 3	White	50,000	•	•
7746	LED-FXSAL180/30K/DB/3S	3000K	180	19,800	400	120-277	Type 3	D.Bronze	50,000	•	
7632	LED-FXSAL180/40K/DB/3S	4000K	180	22,191	400-575	120-277	Type 3	D.Bronze	50,000	•	•
7633	LED-FXSAL180/50K/DB/3S	5000K	180	22,743	400-575	120-277	Type 3	D.Bronze	50,000	•	•
7747	LED-FXSAL180/30K/WH/3S	3000K	180	19,800	400	120-277	Type 3	White	50,000	•	
7634	LED-FXSAL180/40K/WH/3S	4000K	180	22,191	400-575	120-277	Type 3	White	50,000	•	•
7635	LED-FXSAL180/50K/WH/3S	5000K	180	22,743	400-575	120-277	Type 3	White	50,000	•	•
7748	LED-FXSAL240/30K/DB/3S	3000K	240	26,400	500-600	120-277	Type 3	D.Bronze	50,000	•	
7636	LED-FXSAL240/40K/DB/3S	4000K	240	29,794	750-1000	120-277	Type 3	D.Bronze	50,000	•	•
7637	LED-FXSAL240/50K/DB/3S	5000K	240	30,274	750-1000	120-277	Type 3	D.Bronze	50,000	•	•
7749	LED-FXSAL240/30K/WH/3S	3000K	240	26,400	500-600	120-277	Type 3	White	50,000	•	
7638	LED-FXSAL240/40K/WH/3S	4000K	240	29,794	750-1000	120-277	Type 3	White	50,000	•	•
7639	LED-FXSAL240/50K/WH/3S	5000K	240	30,274	750-1000	120-277	Type 3	White	50,000	•	•
7750	LED-FXSAL360/30K/DB/3S	3000K	360	39,600	750-1000	120-277	Type 3	D.Bronze	50,000	•	
7640	LED-FXSAL360/40K/DB/3S	4000K	360	44,796	1000-1500	120-277	Type 3	D.Bronze	50,000	•	•
7641	LED-FXSAL360/50K/DB/3S	5000K	360	45,878	1000-1500	120-277	Type 3	D.Bronze	50,000	•	•
7751	LED-FXSAL360/30K/WH/3S	3000K	360	39,600	750-1000	120-277	Type 3	White	50,000	•	
7642	LED-FXSAL360/40K/WH/3S	4000K	360	44,796	1000-1500	120-277	Type 3	White	50,000	•	•
7643	LED-FXSAL360/50K/WH/3S	5000K	360	45,878	1000-1500	120-277	Type 3	White	50,000	•	•

Ordering Information (277-480V)

Code	Description	CCT	Watt	Lumen	Equiv Wattage	Voltage	Beam Angle	Color	Rated Hrs	IP 65	DLC
7724	LED-FXSAL180/40K/DB/3S/480	4000K	180	22,147	400-575W	277-480	Type 3	D.Bronze	50,000	•	•
7725	LED-FXSAL180/50K/DB/3S/480	5000K	180	22,717	400-575W	277-480	Type 3	D.Bronze	50,000	•	•
7726	LED-FXSAL180/40K/WH/3S/480	4000K	180	22,147	400-575W	277-480	Type 3	White	50,000	•	•
7727	LED-FXSAL180/50K/WH/3S/480	5000K	180	22,717	400-575W	277-480	Type 3	White	50,000	•	•
7728	LED-FXSAL240/40K/DB/3S/480	4000K	240	28,912	750-1000W	277-480	Type 3	D.Bronze	50,000	•	•
7729	LED-FXSAL240/50K/DB/3S/480	5000K	240	29,546	750-1000W	277-480	Type 3	D.Bronze	50,000	•	•
7730	LED-FXSAL240/40K/WH/3S/480	4000K	240	28,912	750-1000W	277-480	Type 3	White	50,000	•	•
7731	LED-FXSAL240/50K/WH/3S/480	5000K	240	29,546	750-1000W	277-480	Type 3	White	50,000	•	•
7732	LED-FXSAL360/40K/DB/3S/480	4000K	360	43,560	1000-1500W	277-480	Type 3	D.Bronze	50,000	•	•
7733	LED-FXSAL360/50K/DB/3S/480	5000K	360	44,405	1000-1500W	277-480	Type 3	D.Bronze	50,000	•	•
7734	LED-FXSAL360/40K/WH/3S/480	4000K	360	43,560	1000-1500W	277-480	Type 3	White	50,000	•	•
7735	LED-FXSAL360/40K/WH/3S/480	5000K	360	44,405	1000-1500W	277-480	Type 3	White	50,000	•	•

Mounting Options

Slip Fitter -SF



Code	Model	Description
P10101	MT-SAL/SF/DB	Slip Fitter for Dark Bronze
P10102	MT-SAL/SF/WH	Slip Fitter for White

Swivel Bracket



Code	Model	Description
P10103	MT-SAL/SB/DB	Swivel Bracket for Dark Bronze
P10104	MT-SAL/SB/WH	Swivel Bracket for White

6" Extruded Arm - EA6

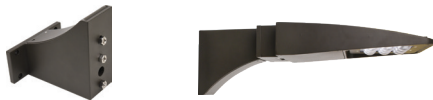

Code	Model	Description
P10105	MT-SAL/EA6/DB	6" Extruded Arm for D. Bronze
P10106	MT-SAL/EA6/WH	6" Extruded Arm for White

Dual Pendant Box



Code	Model	Description
P10107	MT-SAL/DPB/DB	Dual Pendant Box 3/4" NPT D.Bronze
P10108	MT-SAL/DPB/WH	Dual Pendant Box 3/4" NPT White

9" Yoke Mount



Code	Model	Description
P10111	MT-SAL/YK9/DB	9" Yoke Mount for 29-100W, D. Bronze
P10112	MT-SAL/YK9/WH	9" Yoke Mount for 29-100W White

15" Yoke Mount



Code	Model	Description
P10113	MT-SAL/YK15/DB	15" Yoke Mount for 180-360W, D. Bronze
P10114	MT-SAL/YK15/WH	15" Yoke Mount for 180-360W White

### Accessory Options

#### Remote Controlled Motion/PhotoCell Sensor



Code	Model	Description
K136178	PLT/LDB/9SWC	Remote Controllable Sensor 0-10V 3X C Lens (29-100W) Dark Bronze Plate
K136179	PLT/LDB/9SWD	Remote Controllable Sensor 0-10V 2X D Lens (29-100W) Dark Bronze Plate
K137178	PLT/LWH/9SWC	Remote Controllable Sensor 0-10V 3X C Lens (29-100W) White Plate
K137179	PLT/LWH/9SWD	Remote Controllable Sensor 0-10V 100-277V 2X D Lens (29-100W) White Plate
K134178	PLT/SDB/9SWC	Remote Controllable Sensor 0-10V 100-277V 3X C Lens (180-360W) Dark Bronze Plate
K134179	PLT/SDB/9SWD	Remote Controllable Sensor 0-10V 100-277V 2X D Lens (180-360W) Dark Bronze Plate
K135178	PLT/SWH/9SWC	Remote Controllable Sensor 0-10V 100-277V 3X C Lens (180-360W) White Plate
K135179	PLT/SWH/9SWD	Remote Controllable Sensor 0-10V 100-277V 2X D Lens (180-360W) White Plate
P10164	SEN-SRP280	Remote Control

#### Motion/PhotoCell Sensor



Code	Model	Description
K134115	PLT/SB/SWC	Motion/PhotoCell 0-10V 100-277V 3X C Lens (29-100W) Dark Bronze Plate
K134116	PLT/SB/SWD	Motion/PhotoCell 0-10V 100-277V 2X D Lens (29-100W) Dark Bronze Plate
K135115	PLT/SWH/SWC	Motion/PhotoCell 0-10V 100-277V 3X C Lens (29-100W) White Plate
K135116	PLT/SWH/SWD	Motion/PhotoCell 0-10V 100-277V 2X D Lens (29-100W) White Plate
K136115	PLT/LDB/SWC	Motion/PhotoCell 0-10V 100-277V 3X C Lens (180-360W) Dark Bronze Plate
K136116	PLT/LDB/SWD	Motion/PhotoCell 0-10V 100-277V 2X D Lens (180-360W) Dark Bronze Plate
K137115	PLT/LWH/SWC	Motion/PhotoCell 0-10V 100-277V 3X C Lens (180-360W) White Plate
K137116	PLT/LWH/SWD	Motion/PhotoCell 0-10V 100-277V 2X D Lens (180-360W) White Plate

#### PhotoCell Sensor & Short Cap



Code	Model	Description
K141030	REC3PLK/PHO	Receptacle Mount & PhotoCell for SAL
P10053	SEN-PHO-LK-MT/SRT	Twist-Lock Mount Shorting Cap

#### Receptacle



Code	Model	Description
P10141	REC3PLK	3 prong twist lock receptacle mount
P10142	REC7PLK	7 prong twist lock receptacle mount

#### EA6 Adaptor



Code	Model	Description
P10119	MT-SAL/4PA/DB	4" Round pole adaptor for SAL-DB
P10120	MT-SAL/5PA/DB	5" Round pole adaptor for SAL-DB
P10121	MT-SAL/6PA/DB	6" Round pole adaptor for SAL-DB
P10122	MT-SAL/4PA/WH	4" Round pole adaptor for SAL-WH
P10123	MT-SAL/5PA/WH	5" Round pole adaptor for SAL-WH
P10124	MT-SAL/6PA/WH	6" Round pole adaptor for SAL-WH

#### Type 5 Lens



Code	Model	Description
P10127	LENS-SAL-SMALL-V	SAL small type V
P10128	LENS-SAL-LARGE-V/DB	SAL large type V Dark Bronze
P10131	LENS-SAL-LARGE-V/WH	SAL large type V White

Photometric Data

29Watt- Type 3

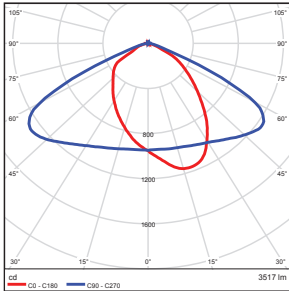

Zonal Lumen Summary

Zone	Lumens	% Luminaire
0-30	808.02	23.00
0-40	1380.33	39.20
0-60	2748.99	78.20
60-80	736.38	20.90
70-80	172.54	4.90
90-120	1.71	0.00
90-180	3.73	0.10
0-180	3517.00	100.00

Total Luminaire Efficiency = 100.00%

Illuminance at a Distance

	Center Beam fc	Beam Width	
5.0ft	38.0 fc	8.5 ft	3.0 ft
10.0ft	9.50 fc	16.9 ft	6.1 ft
15.0ft	4.22 fc	25.4 ft	9.1 ft
20.0ft	2.37 fc	33.9 ft	12.2 ft
25.0ft	1.52 fc	42.3 ft	15.2 ft
30.0ft	1.06 fc	50.8 ft	18.2 ft

■ Vert. Spread: 80.5°  
■ Horiz. Spread: 33.6°

29Watt- Type 5

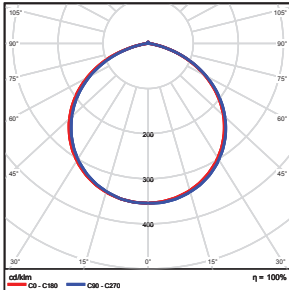

Zonal Lumen Summary

Zone	Lumens	% Luminaire
0-30	991.92	27.80
0-40	1633.2	45.80
0-60	2893.88	81.10
60-80	612.77	17.20
70-80	190.06	5.30
90-120	16.13	0.50
90-180	41.88	1.20
0-180	3573.19	100.20

Total Luminaire Efficiency = 100.00%

Illuminance at a Distance

	Center Beam fc	Beam Width	
5.0ft	50.5 fc	15.1 ft	14.9 ft
10.0ft	12.6 fc	30.2 ft	29.9 ft
15.0ft	5.62 fc	45.4 ft	44.8 ft
20.0ft	3.16 fc	60.5 ft	59.8 ft
25.0ft	2.02 fc	75.6 ft	74.7 ft
30.0ft	1.40 fc	90.7 ft	89.7 ft

■ Vert. Spread: 113.0°  
■ Horiz. Spread: 112.4°

50Watt- Type 3

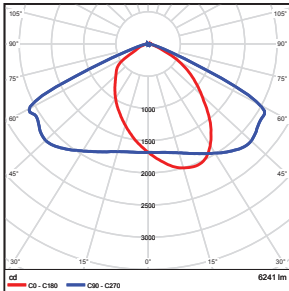

Zonal Lumen Summary

Zone	Lumens	% Luminaire
0-30	1426.12	22.90
0-40	2457.64	39.40
0-60	4955.73	79.40
60-80	1236.3	19.80
70-80	281.74	4.50
90-120	2.74	0.00
90-180	6.39	0.10
0-180	6240.69	100.00

Total Luminaire Efficiency = 100.00%

Illuminance at a Distance

	Center Beam fc	Beam Width	
5.0ft	67.3 fc	9.8 ft	4.7 ft
10.0ft	16.8 fc	19.6 ft	9.4 ft
15.0ft	7.48 fc	29.3 ft	14.1 ft
20.0ft	4.21 fc	39.1 ft	18.8 ft
25.0ft	2.69 fc	48.9 ft	23.5 ft
30.0ft	1.87 fc	58.7 ft	28.2 ft

■ Vert. Spread: 80.7°  
■ Horiz. Spread: 50.3°

50Watt- Type 5

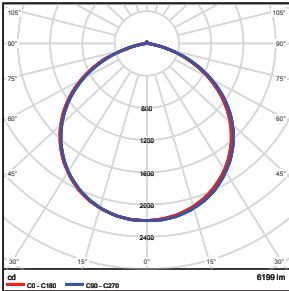

Zonal Lumen Summary

Zone	Lumens	% Luminaire
0-30	1727.63	27.80
0-40	2844.27	45.80
0-60	5038.66	81.20
60-80	1054.29	17.00
70-80	322.59	5.20
90-120	27.86	0.40
90-180	72.57	1.20
0-180	6207.47	100.00

Total Luminaire Efficiency = 100.00%

Illuminance at a Distance

	Center Beam fc	Beam Width	
5.0ft	88.0 fc	15.0 ft	15.1 ft
10.0ft	22.0 fc	30.0 ft	30.1 ft
15.0ft	9.77 fc	44.9 ft	45.2 ft
20.0ft	5.50 fc	59.9 ft	60.2 ft
25.0ft	3.52 fc	74.9 ft	75.3 ft
30.0ft	2.44 fc	89.9 ft	90.3 ft

■ Vert. Spread: 112.6°  
■ Horiz. Spread: 112.8°

Photometric Data

75Watt- Type 3

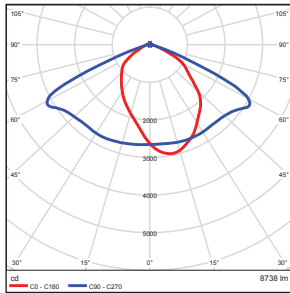

Zonal Lumen Summary

Zone	Lumens	% Luminaire
0-30	2063.73	23.60
0-40	3428.37	39.20
0-60	6762.27	77.40
60-80	1900.34	21.70
70-80	521.62	6.00
90-120	4.12	0.00
90-180	9.14	0.10
0-180	8738.13	100.00

Total Luminaire Efficiency = 100.00%

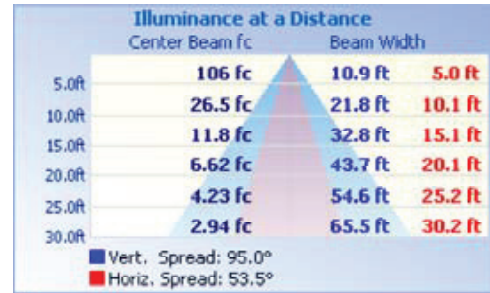

75Watt- Type 5

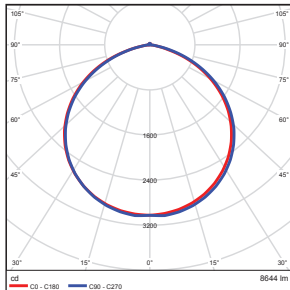

Zonal Lumen Summary

Zone	Lumens	% Luminaire
0-30	2381.12	27.50
0-40	3929.47	45.40
0-60	6997.31	80.80
60-80	1499.67	17.30
70-80	462.55	5.30
90-120	38.92	0.40
90-130	53.67	0.60
90-180	101.05	1.20
0-180	8657.41	100.20

Total Luminaire Efficiency = 100.00%

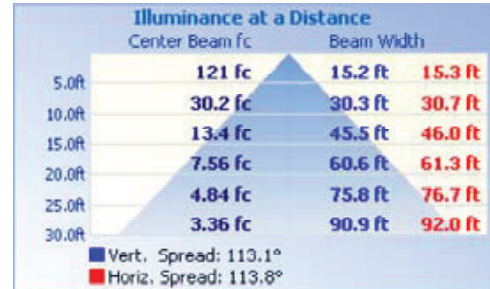

100Watt- Type 3

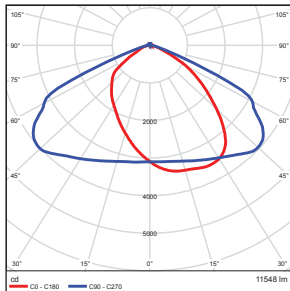

Zonal Lumen Summary

Zone	Lumens	% Luminaire
0-30	2578.11	22.30
0-40	4497.16	38.90
0-60	9183.28	79.50
60-80	2270.09	19.70
70-80	540.29	4.70
90-120	5.17	0.00
90-130	6.81	0.10
90-180	11.90	0.10
0-180	11547.83	100.00

Total Luminaire Efficiency = 100.00%

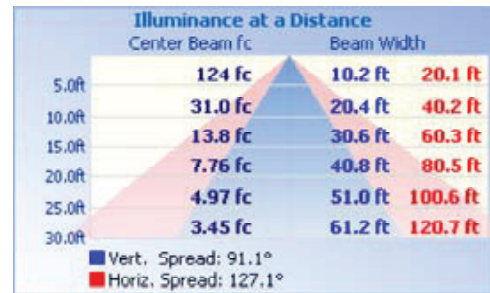

100Watt- Type 5

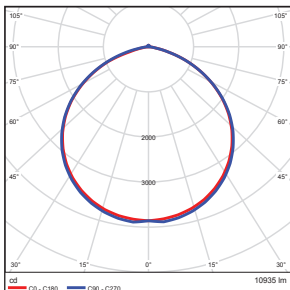

Zonal Lumen Summary

Zone	Lumens	% Luminaire
0-30	3035.57	27.70
0-40	5004.85	45.70
0-60	8883.69	81.10
60-80	1863.68	17.00
70-80	568.50	5.20
90-120	49.07	0.40
90-130	67.71	0.60
90-180	127.76	1.20
0-180	10949.69	100.00

Total Luminaire Efficiency = 100.00%

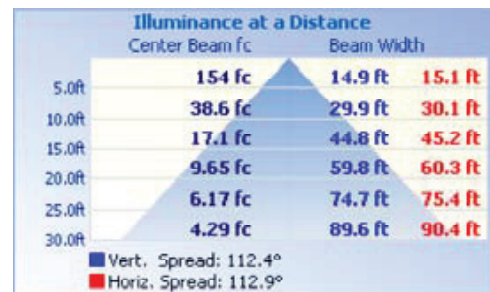

Photometric Data

180 Watt- Type 3

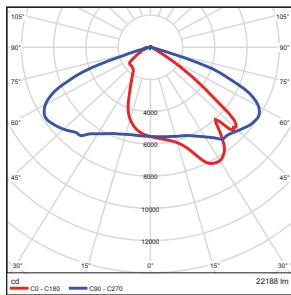

Zonal Lumen Summary

Zone	Lumens	% Luminaire
0-30	4767.93	21.50
0-40	8532.86	38.50
0-60	17764.15	80.10
60-80	4310.05	19.40
70-80	922.31	4.20
90-120	14.29	0.10
90-130	22.73	0.10
90-180	43.44	0.20
0-180	22188.46	100.00

Total Luminaire Efficiency = 100.00%

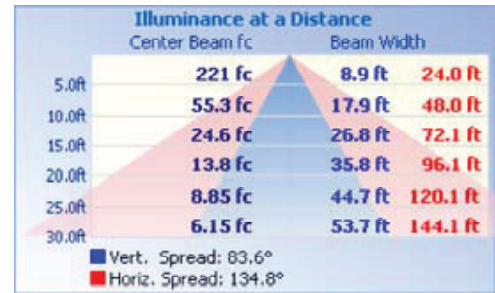

180 Watt- Type 5

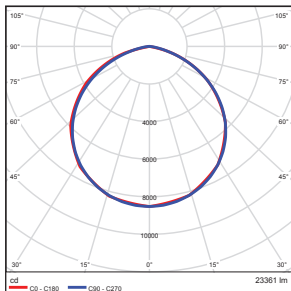

Zonal Lumen Summary

Zone	Lumens	% Luminaire
0-30	6625.12	28.40
0-40	10895.7	6.70
0-60	19240.86	82.40
60-80	4019.51	17.20
70-80	1238.83	5.30
90-120	0.00	0.00
90-130	0.00	0.00
90-180	0.00	0.00
0-180	23353.2	100.00

Total Luminaire Efficiency = 100.00%

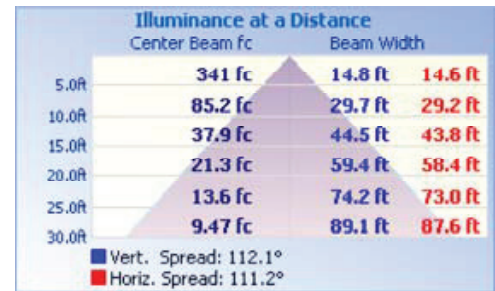

240 Watt- Type 3

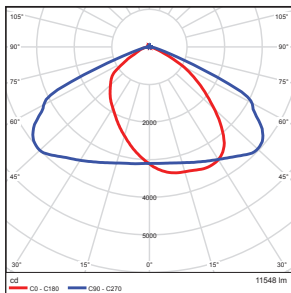

Zonal Lumen Summary

Zone	Lumens	% Luminaire
0-30	2578.11	22.30
0-40	4497.16	38.90
0-60	9183.28	79.50
60-80	2270.09	19.70
70-80	540.29	4.70
90-120	5.17	0.00
90-130	6.81	0.10
90-180	11.90	0.10
0-180	11547.83	100.00

Total Luminaire Efficiency = 100.00%

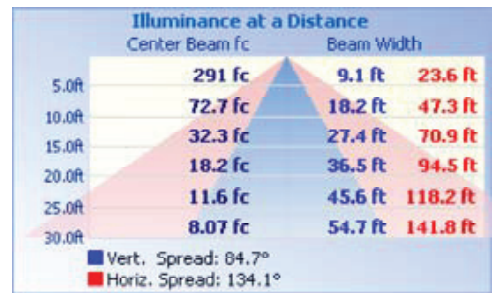

240 Watt- Type 5

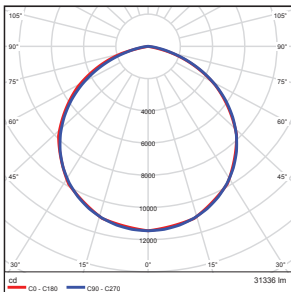

Zonal Lumen Summary

Zone	Lumens	% Luminaire
0-30	8905.68	28.40
0-40	14645.84	46.80
0-60	25848.36	82.50
60-80	5354.7	17.10
70-80	1639.24	5.20
90-120	0.00	0.00
90-130	0.00	0.00
90-180	0.00	0.00
0-180	31325.59	100.00

Total Luminaire Efficiency = 100.00%

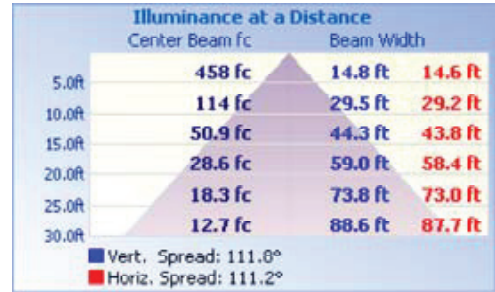

Photometric Data

360 Watt - Type 3

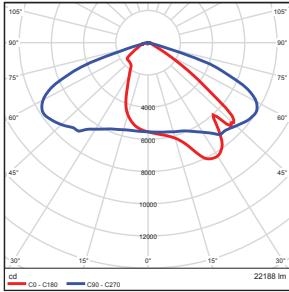

Zonal Lumen Summary

Zone	Lumens	% Luminaire
0-30	4767.93	21.50
0-40	8532.86	38.50
0-60	17764.15	80.10
60-80	4310.05	19.40
70-80	922.31	4.20
90-120	14.29	0.10
90-130	22.73	0.10
90-180	43.44	0.20
0-180	22188.46	100.00

Total Luminaire Efficiency = 100.00%

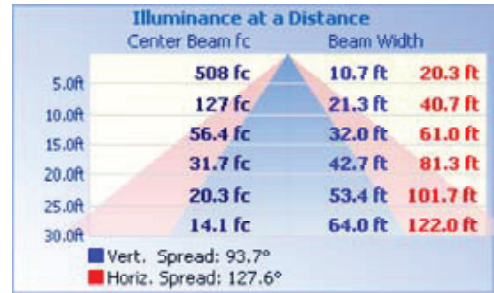

360 Watt - Type 5

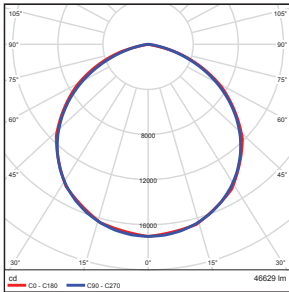

Zonal Lumen Summary

Zone	Lumens	% Luminaire
0-30	13251.89	28.40
0-40	21794.53	46.80
0-60	38466.48	82.50
60-80	7972.82	17.10
70-80	2444.72	5.20
90-120	0.00	0.00
90-130	0.00	0.00
90-180	0.00	0.00
0-180	46614.58	100.00

Total Luminaire Efficiency = 100.00%

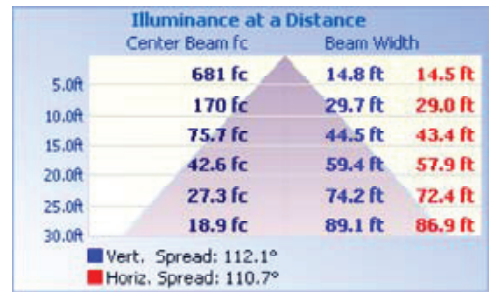



Mounting Dimensions

Slip Fitter -SF

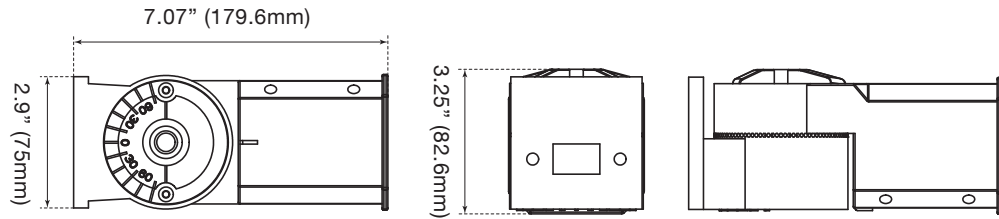
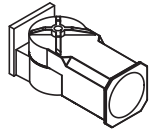

Swivel Bracket -SB

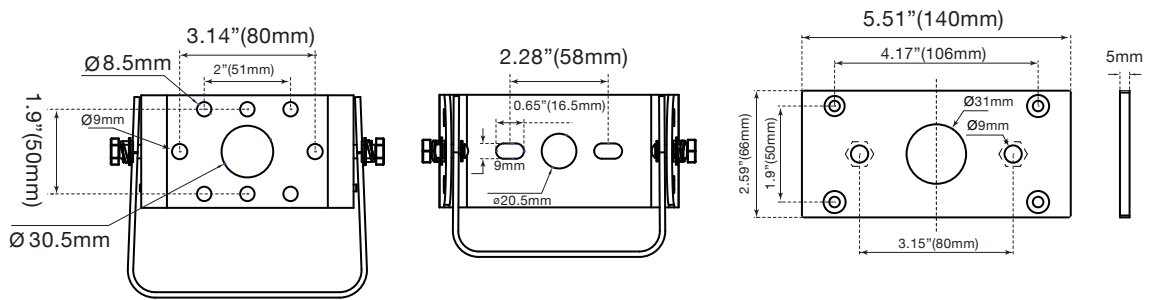
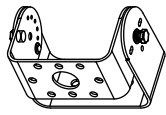

6" Extruded Arm

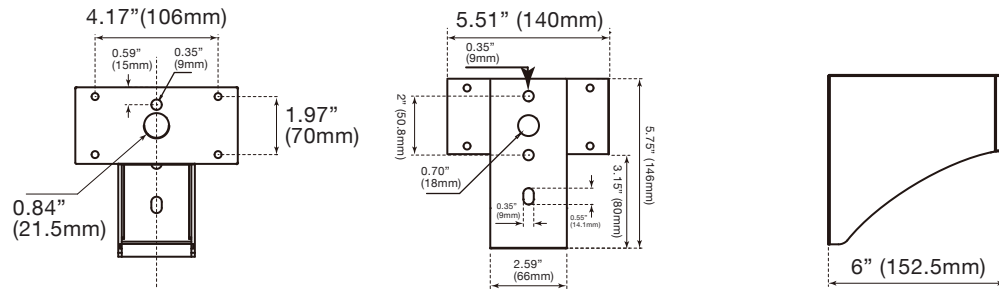
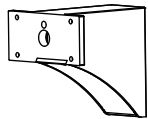

Dual Pendant Box

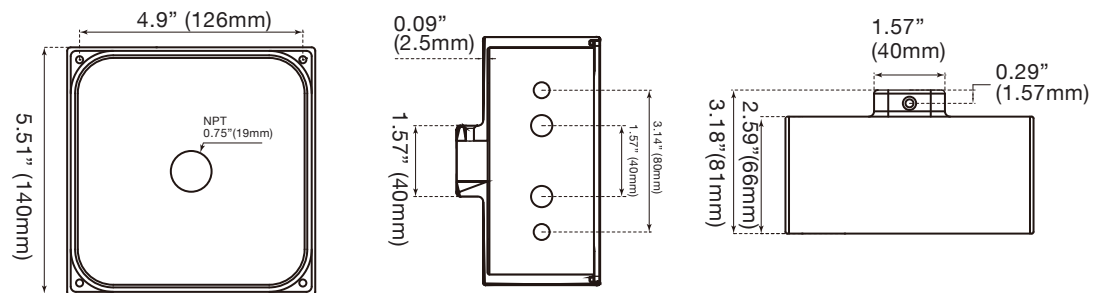
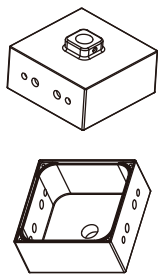

Mounting Dimensions

Yoke - 9"

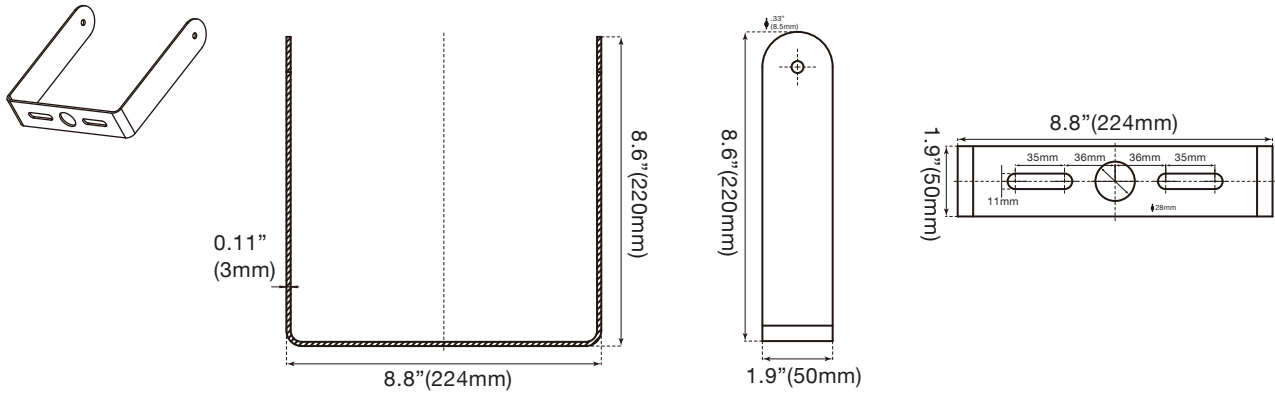

Yoke - 15"

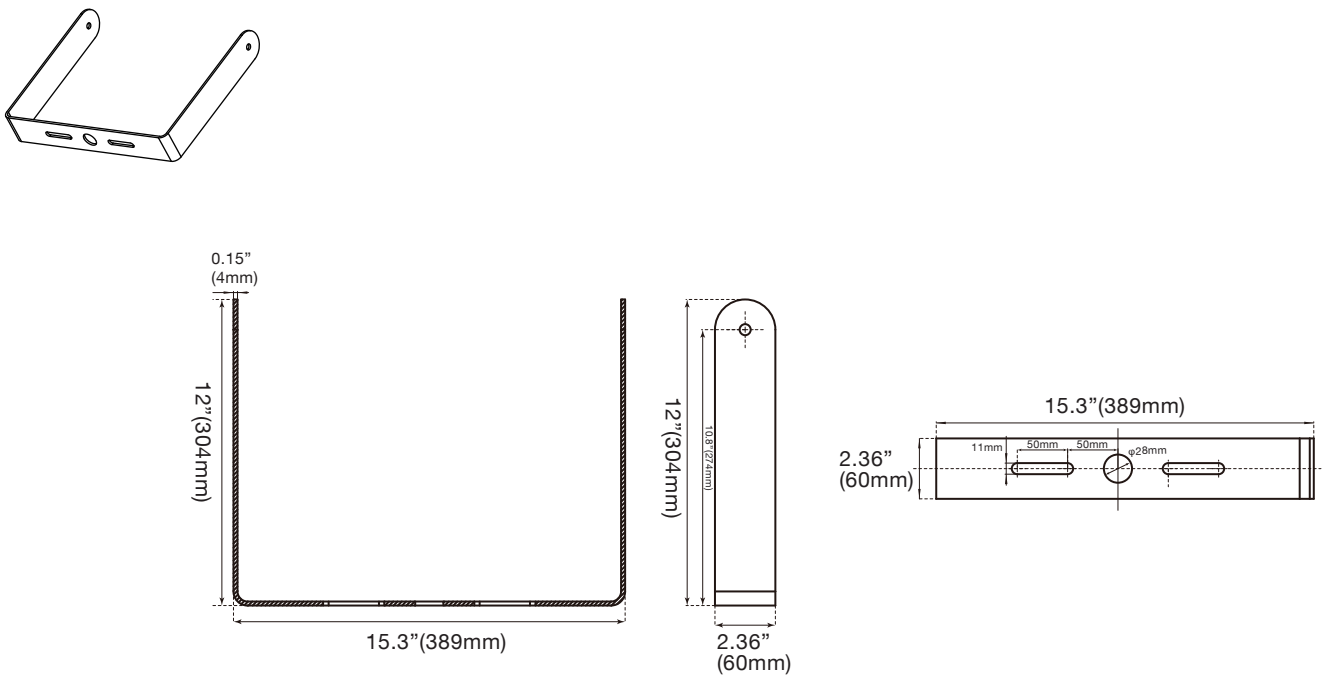

Product Dimensions

29W~100W

29W: 6.75-lbs  
 50W: 7.07-lbs  
 75W: 7.40-lbs  
 100W: 7.76-lbs

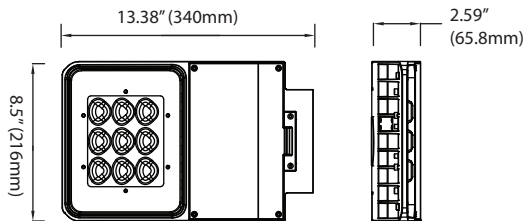

180W

Weight: 21.56-lbs

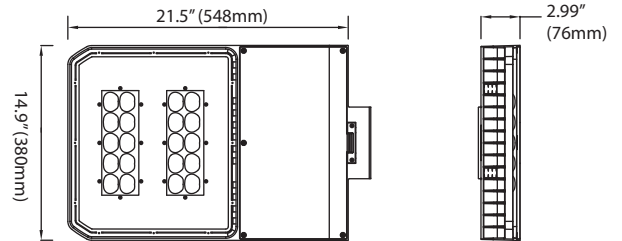

240W

Weight: 22-lbs

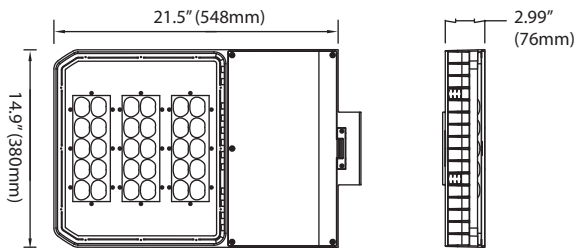

360W

Weight: 25.44-lbs

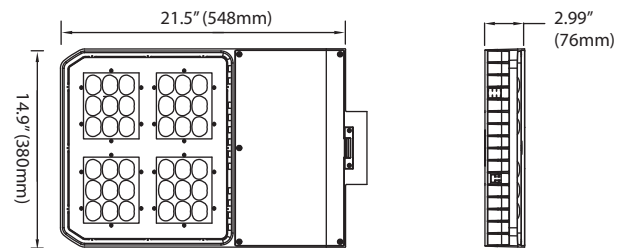

Package

