

SCM SLIM CANOPY

DESCRIPTION

naturaLED® SCM is ETL for wet locations with a rating of IP65. Aesthetically pleasing construction, low-profile design with die-cast aluminum housing and shatter-resistant polycarbonate prismatic lens. Dustproof, sealed structure, 1/2" threaded conduit entrances on each side. This fixture comes with or without an integral microwave occupancy sensor, factory mounted behind the lens. The microwave occupancy sensor has multiple sensor settings that can be selected via dip switch at the sensor brain inside the fixture which include: daylight sensing, step-dimming, area sensitivity, standby time and on/off. The canopy supports both pendant mounting and direct surface mounting ceiling and wall. The fixture can be Pendant Mounted and accepts a 3/4" NPT thread and can be mounted to multiple types of J-boxes.

APPLICATIONS

Warehouses, Parking Garages, Offices, Factories, Hospitals, Hotels

FEATURES

- IP65 Rated
- ETL Listed
- ColorTemp: 4000K, 5000K
- Voltage: 120-277V
- Powerfactor >0.9
- Surge Protection: 2KV
- Dimmable: 1-10V
- CRI: 70
- Operating temperature: - 22°F - 131°F
- Multiple Sensor Settings
- Material: aluminum die-cast
- Shatter-resistant Polycarbonate Lens
- Colors: Black /White
- 5 Year Warranty
- Optional for Purchase: Drop Lens, Frosted Lens, Beauty Plates

PROJECT: _____

SCHEDULE: _____ DATE: _____

PREPARE BY: _____

NOTES: _____



ACCESSORIES

	Beauty Plate
	Drop Lens
	Frosted Lens
	Motion Sensor

SAMPLE NUMBER		LED-FXSCM28/40K/BK-SEN				
STYLE	FAMILY	SERIES	WATTAGE	CRI/COLOR TEMP	COLOR	ACCESSORY
LED	FX	SCM	28	40K	BK	SEN
LED Lighting	Fixture	Slim Canopy	28 Watt	4000K	Black (WH) White	(SEN) Motion Sensor none N/A



ORDERING

*P= Premium DLC / *S = Standard DLC

Watts (W)	Ordering Code	Description	CCT (K)	Lumens (Lm)	Dim (V)	Color	Sensor	IP65 Rated	DLC (S/P)
28	7468	LED-FXSCM28/40K/BK	4000K	3,513	1-10V	Black	-	•	-
42	7471	LED-FXSCM42/50K/BK	5000K	4,682	1-10V	Black	-	•	-
59	7473	LED-FXSCM59/50K/BK	5000K	7,910	1-10V	Black	-	•	P
28	7495	LED-FXSCM28/40K/WH	4000K	3,513	1-10V	White	-	•	-
59	7499	LED-FXSCM59/40K/WH	4000K	7,795	1-10V	White	-	•	P
42	7492	LED-FXSCM42/50K/BK-SEN	5000K	4,784	1-10V	Black	•	•	-
59	7494	LED-FXSCM59/50K/BK-SEN	5000K	7,910	1-10V	Black	•	•	P
28	7480	LED-FXSCM28/50K/WH-SEN	5000K	3,606	1-10V	White	•	•	-
59	7484	LED-FXSCM59/50K/WH-SEN	5000K	7,910	1-10V	White	•	•	P
70	7438	LED-FXSCM70/50K/BK	5000K	5,900	1-10V	Black	-	•	-
70	7564	LED-FXSCM70/50K/BK-SEN	5000K	5,900	1-10V	Black	•	•	-
40	7439	LED-FXSCM70/50K/WH	5000K	5,900	1-10V	White	-	•	-
45	7561	LED-FXSCM45/50K/WH-SEN	5000K	4,150	1-10V	White	•	•	-
70	7565	LED-FXSCM70/50K/WH-SEN	5000K	5,900	1-10V	White	•	•	-

ACCESSORIES (Ordered Separately)

Drop Lens



P10126 LENS-SCM/DR9X9
(Drop Lens for SCM 28W, 42W, 59W)

Motion Sensor



P10234 SEN-MC605V-D
(Microwave Motion Photocell Sensor 0-10V)

Frosted Lens



P10125 LENS-SCM/FR9X9
(Frosted Lens for SCM 28W, 42W, 59W)

Beauty Plates



P10195 PLT-SCM/14X14/WH
(14"x14" Beauty Plate used with SCM)

P10196 PLT-SCM/24X24/WH
(24"x24" Beauty Plate used with SCM)

DIMENSIONS

28W 42W 59W
4.50-lbs 5.10-lbs 5.10-lbs

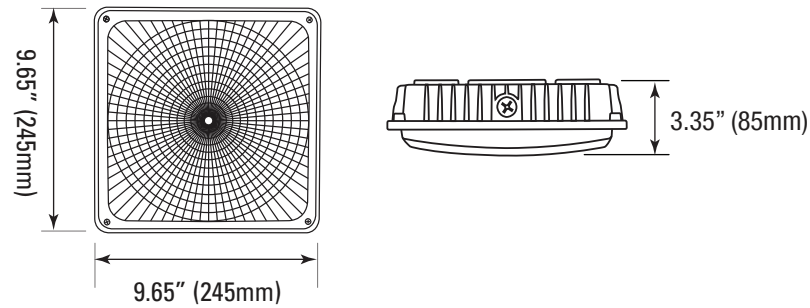

PHOTOMETRICS CHART

28 Watt
Slim Lens

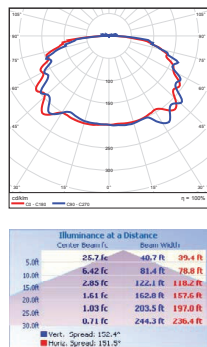

42 Watt
Slim Lens

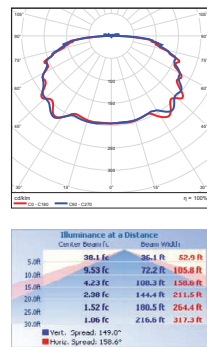

59 Watt
Slim Lens

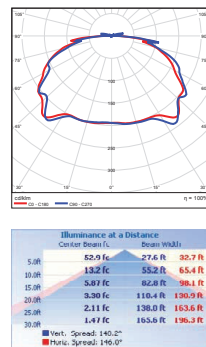

28 Watt
Tall Lens

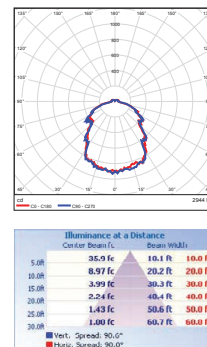

42 Watt
Tall Lens

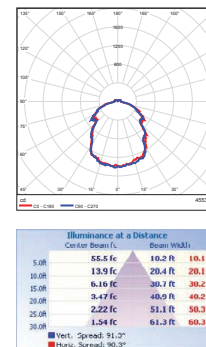

59 Watt
Tall Lens

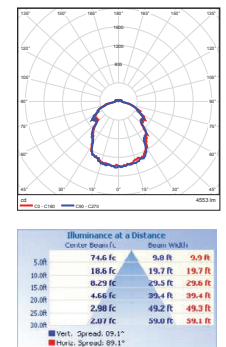

PACKAGE

Case Qty 1 pc

