



Advance Xitanium range of downlight LED Drivers are designed to provide OEMs with ultimate flexibility. These models are compatible with standard 0-10V dimming systems to deliver reliably smooth dimming performance down to a minimum of 1%. Enabled with SimpleSet technology, these drivers offer the needed flexibility & performance for the application with precise tuning of drive currents, selectable dimming curves and adjustable minimum dimming levels. With wide operating windows, compact size and simple current adjustability, luminaire manufacturers can easily design downlight fixtures with desired lumen levels to suit the application.

Specifications

Input Volt. (Vac)	Output Power (W)	Output Volt. (V)	Output Current (A)	Efficiency@ Max. Load and 70°C Case (%)	Max. Case Temp. (°C)	Input Current (A)	Max. Input Power (W)	THD @ Max. Load (%)	Power Factor @ Max. Load	Surge Protection (Ring-Wave, KV)	Envir. Protection Rating
120	25	10-54	0.10/1.0	84	Tc-life: 80°C Tc-UL: 90°C	0.25	31.3	<10%	>0.95	> 2.5	UL damp & dry
277				86		0.11		<15%			

Wiring Diagram

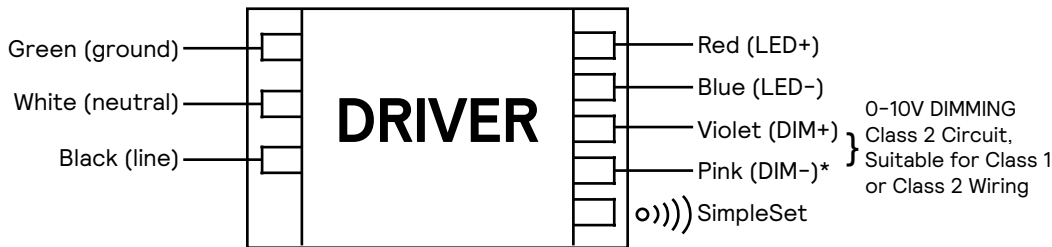

*DIM- will change from GREY to PINK from 2021 onwards.

WARNING

- Install in accordance with national and local electrical codes.
- Use 18 AWG Solid Copper Wire Rated $\geq 90^\circ\text{C}$.
- Strip Wire 3/8".
- For Class 2 wiring, use 20 AWG-16 AWG.

Dimming	Dimming Range	Minimum Output Current (A)	Other Comments
0-10V Suitable for Class 1 or Class 2 Wiring	1% - 100%	0.002	Dimming source current: 150µA

GROUNDING

- Driver case must be grounded.

Xitanium XI025C100V054BSM2 (bottom entry) XI025C100V054BSD2 (side entry)

25W 0.1-1.0A 54V 0-10V INT (1% dim) with SimpleSet

Mechanical Diagram

XI025C100V054BSM2 (bottom entry)

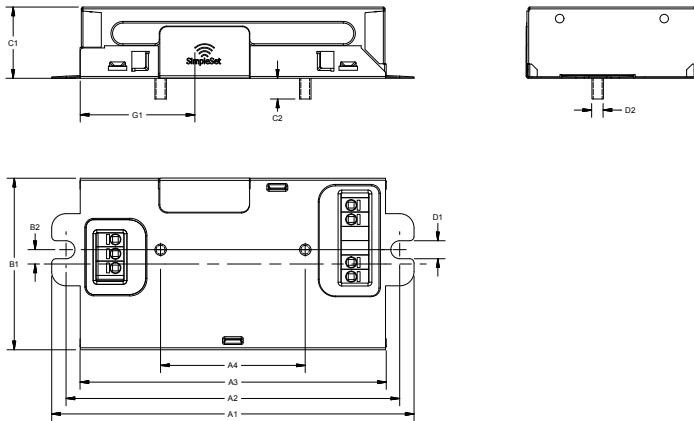

Enclosure

XI025C100V054BSM2 (bottom entry)

	In (mm)	Tolerance (mm)
Overall Length (A1)	4.98 (126.6)	± 0.5
Mounting Hole Distance (A2)	4.59 (116.6)	± 0.5
Case Length (A3)	4.21 (107.0)	± 0.5
Stud Distance (A4)	2.00 (50.7)	± 0.5
Case Width (B1)	2.36 (59.9)	± 0.5
Mounting Hole Distance (B2)	0.20 (5.0)	± 0.5
Case Height (C1)	0.98 (24.9)	± 1.0
Stud Height (C2)	0.28 (7.2)	± 0.5
Mounting Hole Diameter (D1)	0.25 (6.3)	± 0.3
Stud Diameter (D2)	#8-32	N/A
Center of SimpleSet Antenna (G1)	1.55 (39.4)	± 3.0

Mechanical Diagram

XI025C100V054BSD2 (side entry)

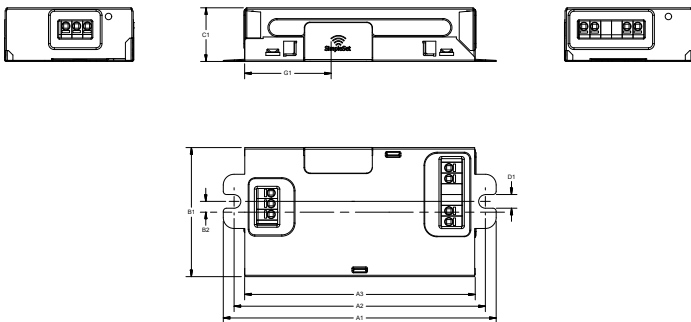

Enclosure

XI025C100V054BSD2 (side entry)

M1 can	In. (mm)	Tolerance (mm)
Overall Length (A1)	4.98 (126.6)	± 0.5
Mounting Hole Distance (A2)	4.59 (116.6)	± 0.5
Case Length (A3)	4.21 (107.0)	± 0.5
Case Width (B1)	2.36 (59.9)	± 0.5
Mounting Hole Distance (B2)	0.20 (5.0)	± 0.5
Case Height (C1)	0.98 (24.9)	± 1.0
Mounting Hole Diameter (D1)	0.25 (6.3)	± 0.3
Center of SimpleSet Antenna (G1)	1.55 (39.4)	± 3.0

Xitanium XI025C100V054BSM2 (bottom entry)

XI025C100V054BSD2 (side entry)

25W 0.1-1.0A 54V 0-10V INT (1% dim) with SimpleSet

Features

- 50,000+ hour lifetime¹
- SimpleSet Programmable
- Large operating window
- 1% minimum dim level
- Compatible with Philips Fortimo Downlight modules

Benefits

- SmartMate style housing enables easy design-in with excellent thermal performance
- Enables Simple, Fast, Flexible application-specific configurations
- Enables fixture designs with comprehensive application coverage for various loads and lumen levels
- A single source system offer optimized for performance

Application

- Indoor Downlight applications
- Wall sconces and ceiling surface luminaires
- Retail
- Hospitality
- Offices (corridors, conference rooms, lobby areas)
- Floodlights

Electrical Specifications

All the specifications are typical and at 25°C Tcase unless specified otherwise.

Product Data

Order Information	
Full Product Code	XI025C100V054BSM2 [bottom entry] (Mid-Pack, 16pcs/Box), 12NC: 929002720813 XI025C100V054BSD2 [side entry] (Mid-Pack, 16pcs/Box), 12NC: 929002720913
Line Frequency	50/60Hz
Min. Mains Voltage Operational	108Vac
Max. Mains Voltage Operational	305Vac
Output Information	
Maximum Open Circuit Voltage	<=60Vdc (Class 2 Output)
Output Current Ripple (ripple = peak to average / average)	15% max @ max lout / 4% max @ Frequency range 60Hz-3KHz
Output Current Tolerance (In the performance window)	<5%
Flicker	Pst:≤0.5 / SVM:≤1.0
Protections	Short Circuit and Open Circuit Protection for LED + and LED- and Temperature Foldback
Features	
0-10V Dimming	150µA source current from driver. See dim curve for detail
AOC (Adjustable Output Current)	0.1A-1.0A via SimpleSet programming (refer to graph and notes below)
Additional SimpleSet Configurable Features	Adjustable minimum dimming level, Dimming curve selection (Linear or Logarithmic), Adjustable Output level, Adjustable Output Min, OEM Write Protection, Dim to off function
Environment & Approbation	
Operating Ambient Temp. Range	-40°C to +50°C
UL Max Case Temperature (Tcase)	90°C
Agency Approbations	UL8750, CSA-C22.2 No. 250.13, NOM, Class P(ETL, cUL, UL),UL60730 SREC
Electromagnetic Compliance	FCC Title 47 Part 15 Class B for 120Vac; FCC Title 47 Part 15 Class A for 277Vac
Audible Noise	<24dB Class A
Weight	0.44 Lbs / 0.2 kgs

1. Advance Xitanium LED Drivers are manufactured to engineering standards correlating to a designed and average life expectancy of 50,000 hours of operation at maximum rated case temperature. Minimum 90% survivals based on MTBF modeling.

Xitanium XI025C100V054BSM2 (bottom entry)

XI025C100V054BSD2 (side entry)

25W 0.1-1.0A 54V 0-10V INT (1% dim) with SimpleSet

Electrical Specifications

All the specifications are typical and at 25°C Tcase unless specified otherwise.

0-10V Dimming Interface

Dimming source current from the driver: 150µA (@ 0<Vdim<8V)
 Minimum Dim Level: 1% of Iout (minimum 2mA)
 Maximum output voltage on the dimming wires: 12V

Standby Power: 0.5W
 Leakage current of dimming leads: 0.005mA, recommended max number of control circuits in parallel refer to Design-In Guide

0-10V Dimming Interface

Symbol	Parameter	Min	Typical	Max	Unit
Von	Turn on threshold	0.7	0.8	0.9	V
Voff	Turn off threshold	0.4	0.5	0.6	V
Ton	Turn on time	-	-	250	mS
Toff	Turn off time	-	-	1000	mS

Approved Dimmer List

Manufacturer	Manufacturer Part Number
Lutron	Visit www.lutron.com/advance for a list of dimmers (Mark VII) that will work with this driver
Leviton	IllumaTech IP7 series
Philips	Sunrise - SR1200ZTUNV

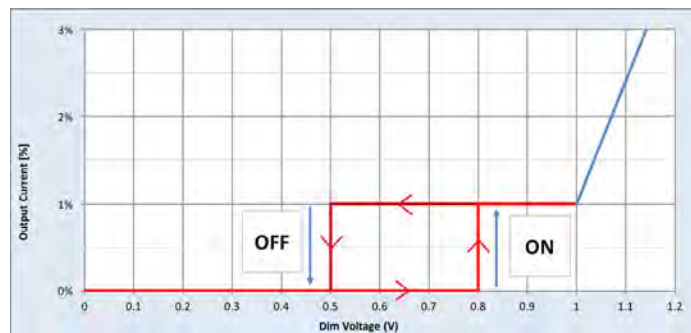
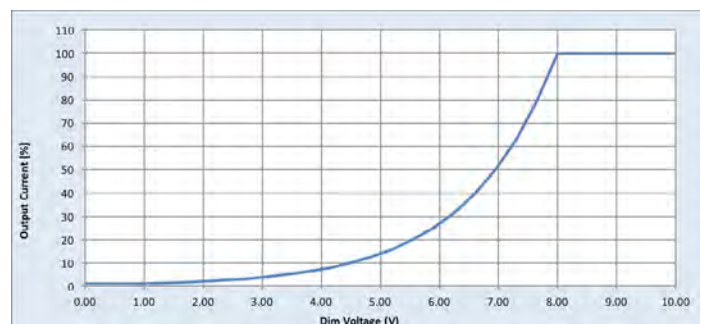
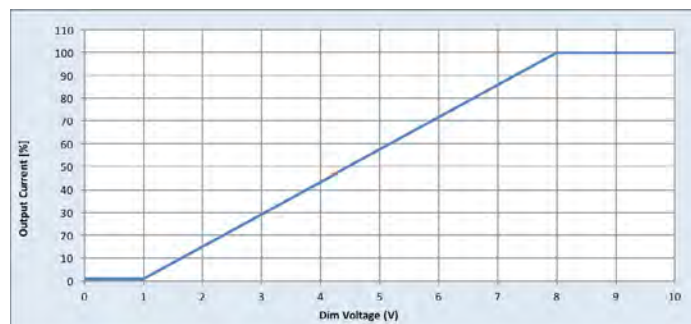

Xitanium XI025C100V054BSM2 (bottom entry) XI025C100V054BSD2 (side entry)

25W 0.1-1.0A 54V 0-10V INT (1% dim) with SimpleSet

Electrical Specifications

All the specifications are typical and at 25°C Tcase unless specified otherwise.

Operating Window

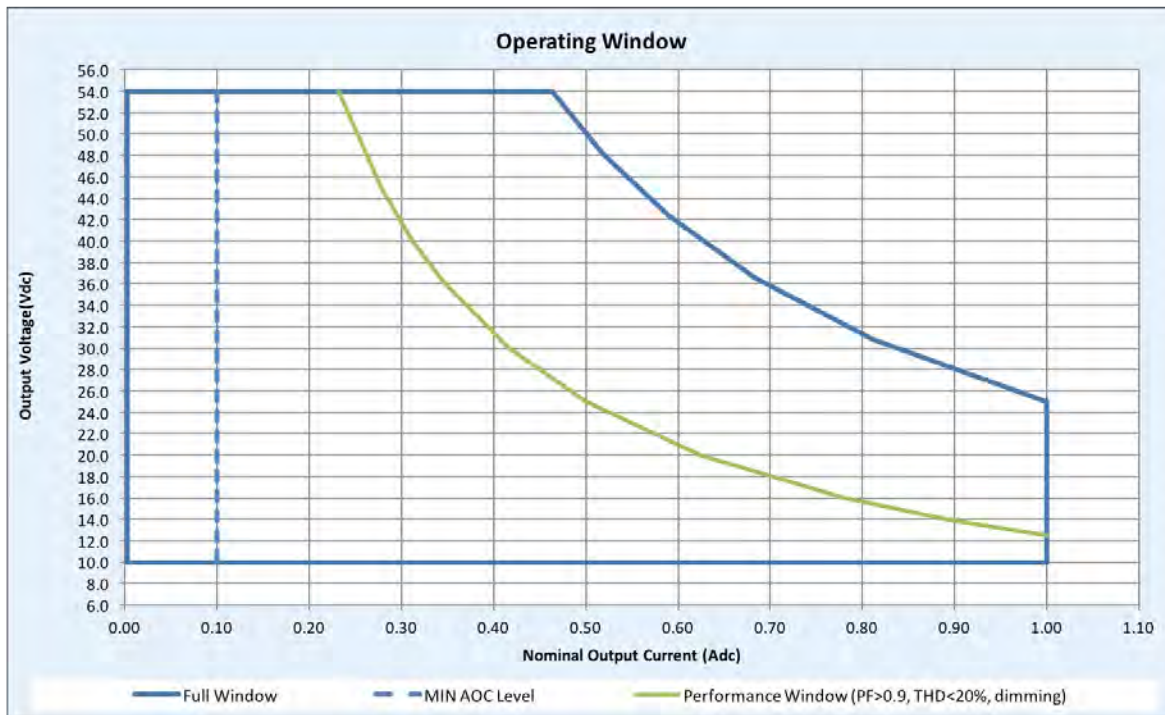

NOTE:

1. Factory default output current is 1.0A
2. For dimming to a minimum level of 1% the output current setting through AOC should be $\geq 0.2A$

Xitanium XI025C100V054BSM2 (bottom entry) XI025C100V054BSD2 (side entry)

25W 0.1-1.0A 54V 0-10V INT (1% dim) with SimpleSet

Electrical Specifications

All the specifications are typical and at 25°C Tcase unless specified otherwise.

Output Current Vs. Driver Case Temperature

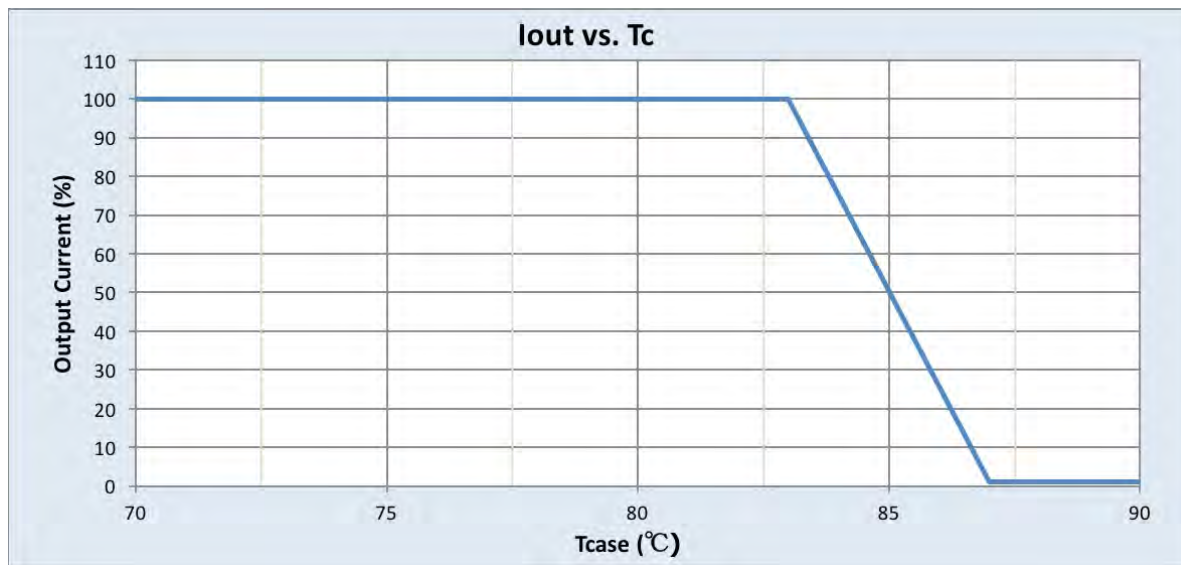

Driver Lifetime vs. Driver Case Temperature

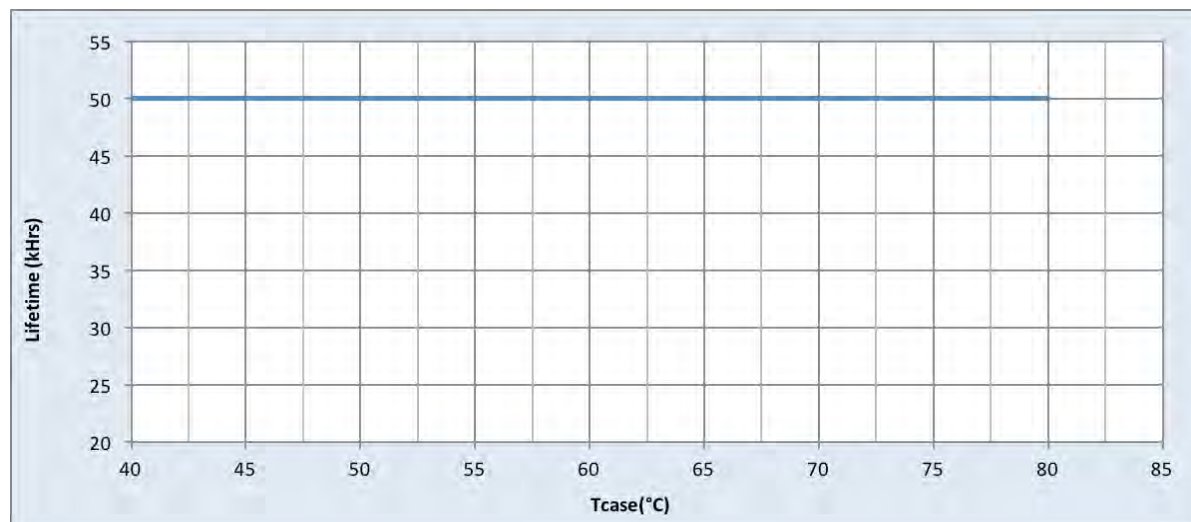

Xitanium XI025C100V054BSM2 (bottom entry) XI025C100V054BSD2 (side entry)

25W 0.1-1.0A 54V 0-10V INT (1% dim) with SimpleSet

Performance Characteristics

Based on measurements on a typical sample at 80°C case. The accuracy of the measurements is within the tolerance of the measurement instruments. The graphs are meant to be a guideline and not a specification.

Efficiency Vs. Output Voltage 120V

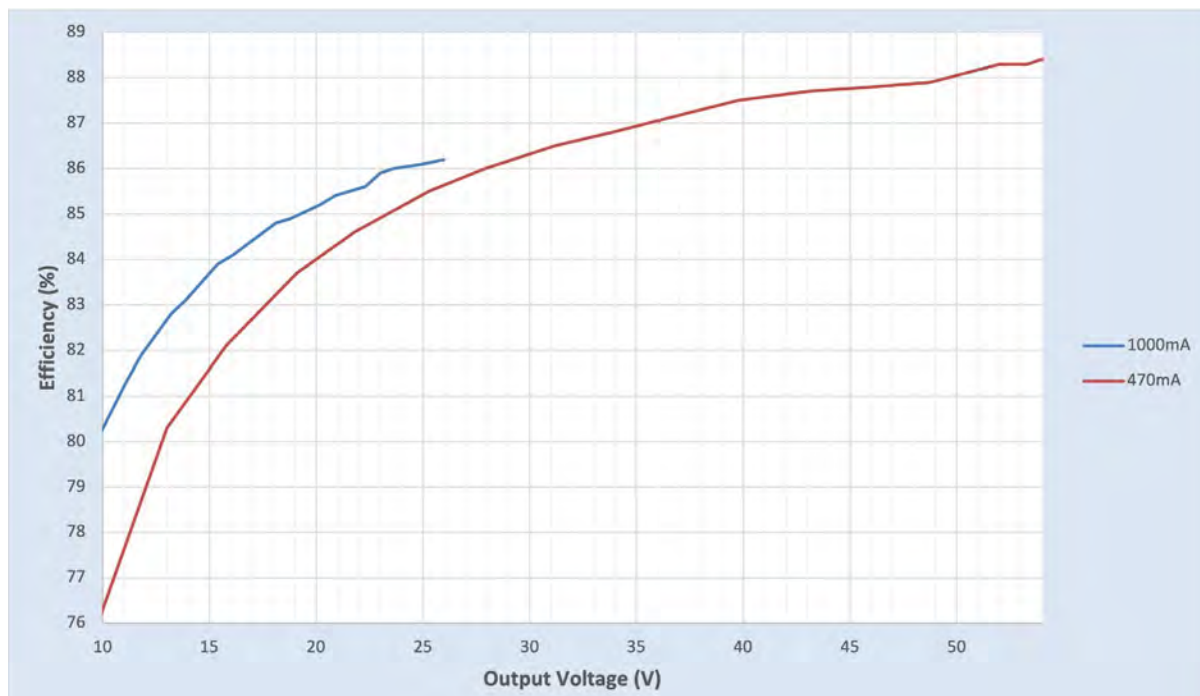

Efficiency Vs. Output Voltage 277V

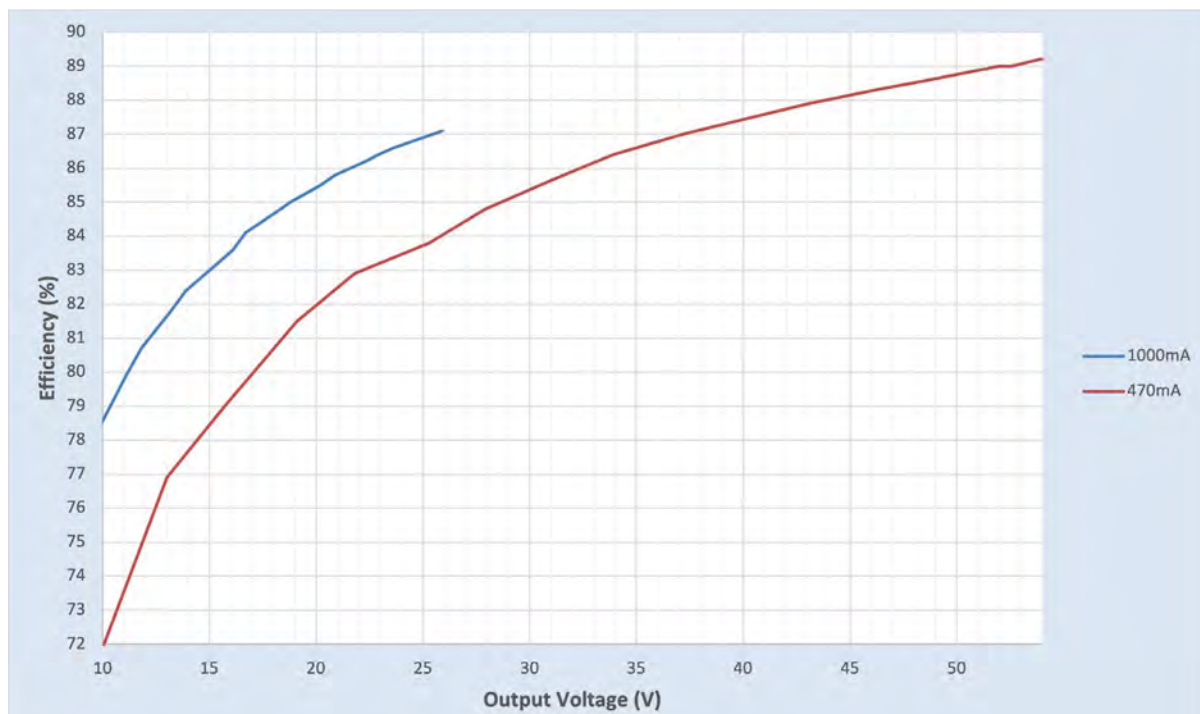

Xitanium XI025C100V054BSM2 (bottom entry) XI025C100V054BSD2 (side entry)

25W 0.1-1.0A 54V 0-10V INT (1% dim) with SimpleSet

Performance Characteristics

Based on measurements on a typical sample at 80°C case. The accuracy of the measurements is within the tolerance of the measurement instruments. The graphs are meant to be a guideline and not a specification.

Power Factor Vs. Output Power

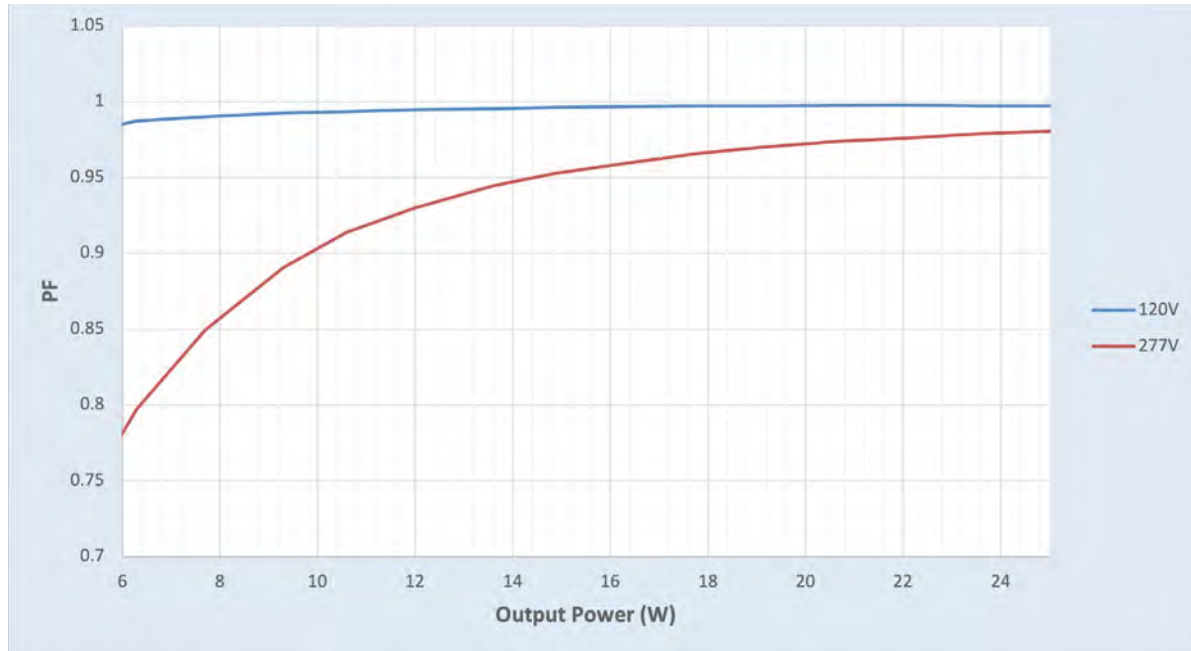

Total Harmonic Distortion (THD) Vs. Output Power

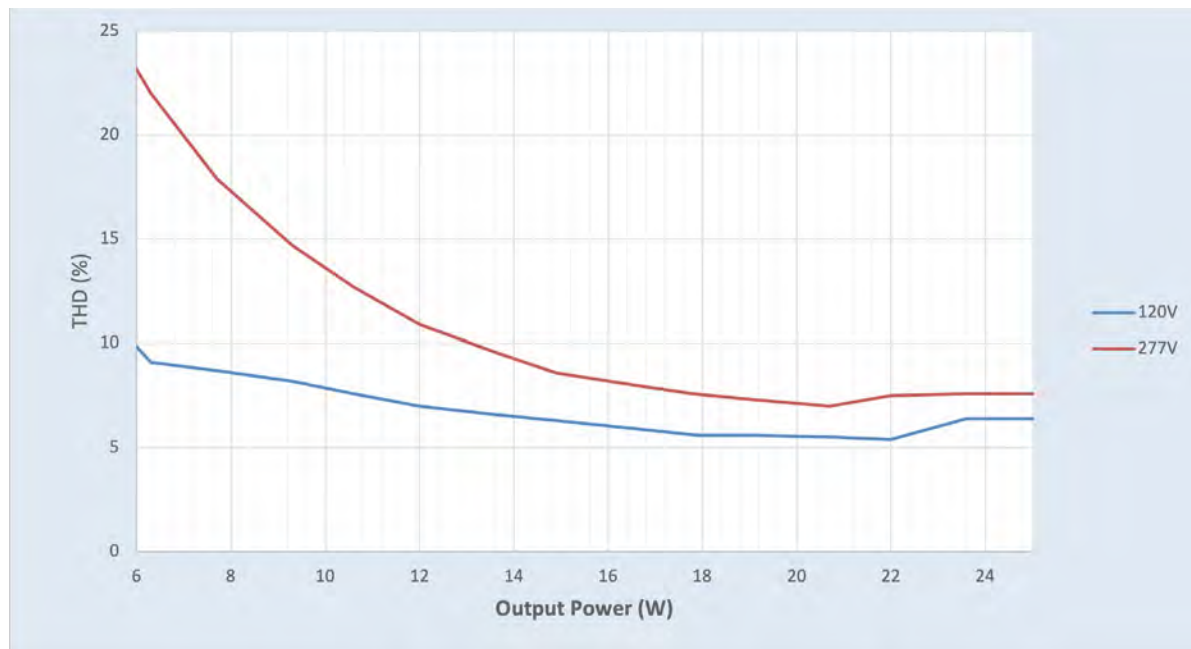

Xitanium XI025C100V054BSM2 (bottom entry) XI025C100V054BSD2 (side entry)

25W 0.1-1.0A 54V 0-10V INT (1% dim) with SimpleSet

Inrush Current Info

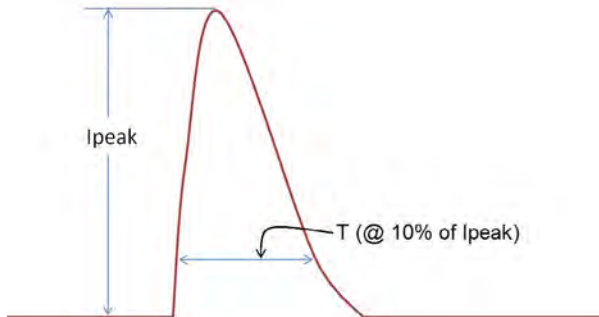

V_{in}	I_{peak}	T (@ 10% of I_{peak})
120 Vrms	10A	62 μ S
277 Vrms	26A	73 μ S

Inrush current is measured at peak of the corresponding line voltage. Source impedance per NEMA 410.

Lightning Surge Info

ANSI Surge Type	Differential Mode (L-N)	Common Mode (L-G, N-G, L&N-G)
100kHz Ring Wave (w/t 30 Ω)	>2.5KV	>2.5KV

Isolation

Isolation	Input	Output	0-10V	Enclosure
Input	-	2xU+1kV	2xU+1kV	2xU+1kV
Output	2xU+1kV	-	2xU+1kV	500V
0-10V	2xU+1kV	2xU+1kV	-	2xU+1kV
Enclosure	2xU+1kV	500V	2xU+1kV	-

U = Max input voltage

UL Conditions of Acceptability

Please contact your representative for a copy of the latest UL Conditions of Acceptability (COA).



© 2021 Signify Holding. All rights reserved. The information provided herein is subject to change, without notice. Signify does not give any representation or warranty as to the accuracy or completeness of the information included herein and shall not be liable for any action in reliance thereon. The information presented in this document is not intended as any commercial offer and does not form part of any quotation or contract, unless otherwise agreed by Signify.

Signify North America Corporation
200 Franklin Square Drive,
Somerset, NJ 08873
Telephone 855-486-2216

Signify Canada Ltd.
281 Hillmount Road,
Markham, ON, Canada L6C 2S3
Telephone 800-668-9008

All trademarks are owned by Signify Holding or their respective owners.