

SAFETY INSTRUCTIONS: Read instructions carefully before attempting to install fixture.

- Fixture must be wired in accordance with the National Electrical Code and all applicable local codes.
- Proper grounding is required for safety.
- This product must be installed in accordance with the applicable installations code by a person familiar with the construction and operation of the product and the hazards involved.

CAUTION: Risk of fire

- **Risk of electrical shock!** Disconnect power before installing or servicing.
- To prevent early lamp failure, lamp should only be installed in operating environments ranging between -30°C and +40°C (-22 °F and +104°F).
- No user serviceable parts inside. To avoid electrical shock, do **NOT** disassemble the product.
- **WARNING:** Risk of fire or electric shock, installation requires knowledge of luminaires electrical systems. If not qualified, do **NOT** attempt installation. Contact a qualified electrician.
- Do **NOT** make or alter any open holes in an enclosure of wiring or electrical components during kit installation.
- **WARNING:** To prevent wiring damage or abrasion, do **NOT** expose wiring to edges of sheet metal or other sharp objects.
- Installers should **NOT** disconnect existing wires from lamp holder terminals to make new components at lamp holder terminals. Instead installers should cut existing lamp holder leads away from the lamp holder and make new electrical connections to the lamp holder lead wires by employing applicable connectors.
- This fixture is accepted as a component of a luminaire where the suitability of the combination shall be determined by authorities having jurisdiction. Product must be installed by a qualified electrician in accordance with the applicable and appropriate electrical codes. The installation guide does not supersede local national regulations for electrical installation.
- Caution: Risk of fire! Consult a qualified electrician to ensure the correct branch circuit conductor.

CLEANING & MAINTENANCE:

CAUTION: Be sure the fixture temperature is cool enough to touch. Do **NOT** clean or maintain while the fixture is energized.

1. Clean frosted polystyrene lens and fixture with non-abrasive cleaning solution.
2. Do **NOT** open fixture to clean the LEDs. Do **NOT** touch the LEDs.

Note: These instructions do not cover all details or variation in equipment, nor do they provide for every possible situation during installation, operation or maintenance.

INSIDE THE BOX:

This luminaire has been modified to operate LED lamps. Do **NOT** attempt to install or operate fluorescent lamps in this luminaire.

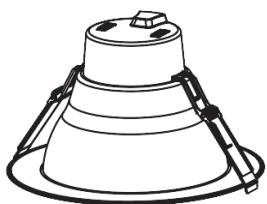

Down Light (1)



Wire Nuts (5)



Template (1)

INSTALLATION WITH EXISTING FRAME

1. Turn the power OFF.
2. Remove the old housing for lamp. (Fig. 1)
3. Attach the carabiner safety clip to the existing fixture housing. (Fig. 2)
4. Remove the junction box faceplate. Disconnect all wires to the ballast and remove the ballast from the J-box. Remove appropriate round knockout. Connect incoming power (**white to white, black to black and green to green/ground**). For 0-10V dimming circuits, connect **grey to grey and purple to purple**. Reattach the J-box faceplate. (Fig. 3)
5. Adjust the fixture power to desired lumen output by sliding the **black** selector switch. Adjust the color temperature to desired one, by sliding the **red** selector switch. (Fig. 4)
6. Install the down light by lifting both retention tabs upward. (Fig. 5)
7. Push until the trim sits flush against the ceiling. (Fig. 6)
8. Restore power at the source and the installation is complete.

Fig. 1

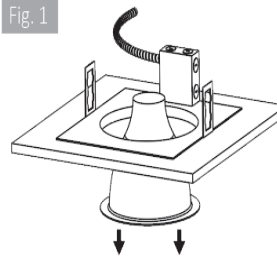

Fig. 2

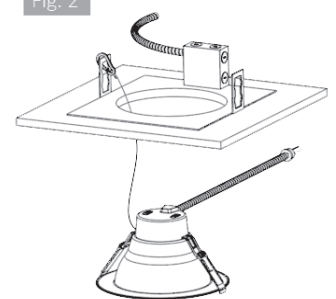

Fig. 3

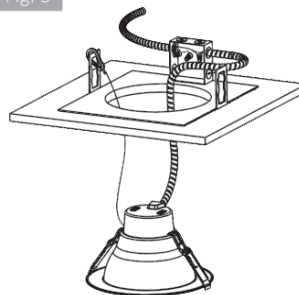

Fig. 4

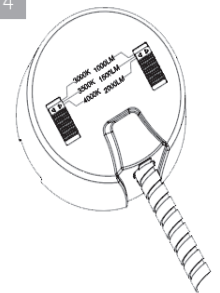

Fig. 5

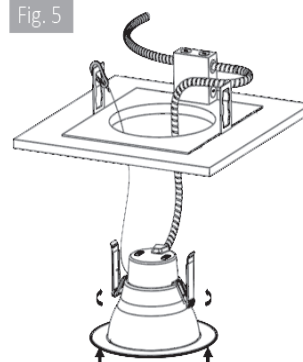
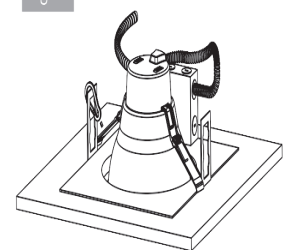

Fig. 6



INSTALLATION WITHOUT EXISTING FRAME:

1. Make sure the power is turned OFF at the source to the location in which you are installing the product.
2. Use the template from inside the box to cut a hole in the ceiling. (Fig. 7)
3. Select desired lumen output and CCT. (Fig. 8)
4. Insert lamp conduit into a preinstalled J-box (not provided) and wire to the power source (**black to hot, white to neutral and green to ground**). For -10V dimming circuits, connect **grey to grey** and **purple to purple**. Close the J-box securely. Install the down light by lifting both retention tabs upward. (Fig. 9)
5. Push until the trim sits flush against the ceiling. (Fig. 10)

Fig. 7

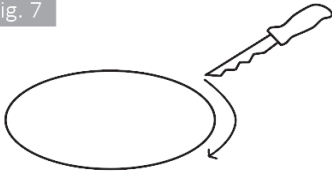

Fig. 8

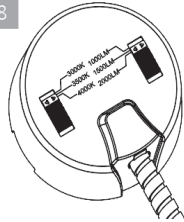

Fig. 9

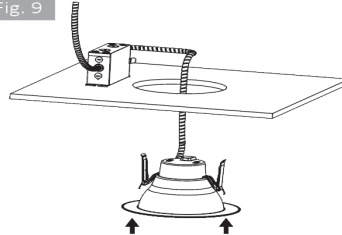
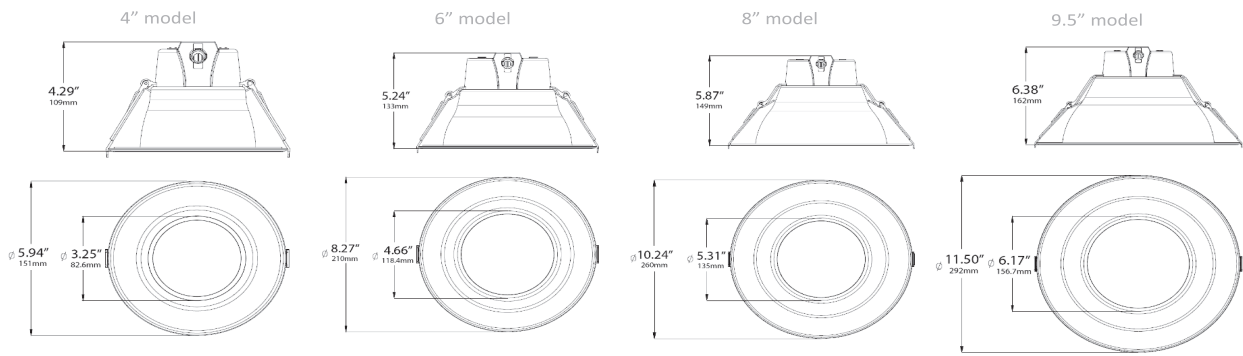
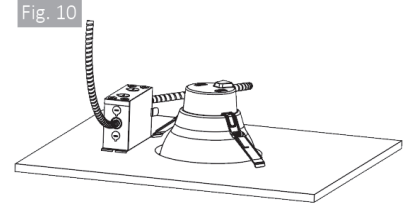
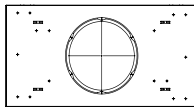

Fig. 10



INSTALLATION GUIDE MODEL #:



4"/6"/8"/9.5" LED Construction Plate for T-Grid Ceiling

PLEASE REVIEW THE INSTRUCTIONS AND WARNINGS LISTED BELOW PRIOR TO PROPER INSTALLATION

Mounting plate for new construction or remodel T-Grid ceilings.

Read carefully before installing a fixture. Retain these instructions for future reference. This fixture must be wired in accordance with the National Electrical Code and all applicable local codes. Proper grounding is required for safety. This product must be installed in accordance with the applicable installation code by a person familiar with the construction and operation of the product and the hazards involved.

WARNINGS

- All product labels and instructions must be read before the fixture is installed
- Ensure safety by wearing safety gloves and other necessary safety gear

INSTALLATION

1. Use cutting pliers to remove any necessary CKO parts to install the downlight. (fig. 1)
2. Position the TGridPlate on the T-Grid where the downlight is to be installed. Once positioned, screw plate to T-Grid through flange holes. (fig. 2)
3. Once plate is attached to T-Grid, cut a hole in the tile following the circumference of the selected CKO. (fig. 3)
4. To complete installation, follow appropriate downlight installation instructions. (fig. 4)

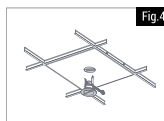
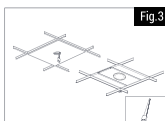
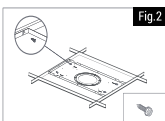
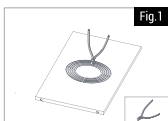

INSTALLATION GUIDE MODEL #:

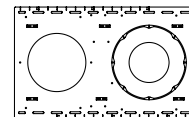

4"/6"/8" LED Construction Plate for Stud/Joist

PLEASE REVIEW THE INSTRUCTIONS AND WARNINGS LISTED BELOW PRIOR TO PROPER INSTALLATION

Mounting plate for new construction Stud/Joist ceilings.

Read carefully before installing a fixture. Retain these instructions for future reference. This fixture must be wired in accordance with the National Electrical Code and all applicable local codes. Proper grounding is required for safety. This product must be installed in accordance with the applicable installation code by a person familiar with the construction and operation of the product and the hazards involved.

WARNINGS

- All product labels and instructions must be read before the fixture is installed
- Ensure safety by wearing safety gloves and other necessary safety gear

INSTALLATION

1. Use cutting pliers to remove any necessary CKO parts to install the downlight. (fig. 1)
2. Stud/JoistPlate must be nailed or screwed to the ceiling's studs/joists. (fig. 2)
3. If necessary, make any required electrical connections.
4. To complete installation, follow appropriate downlight installation instructions. (fig. 3)

